

CLASSIC 820

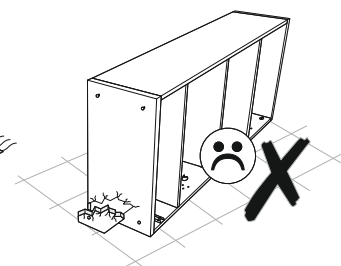

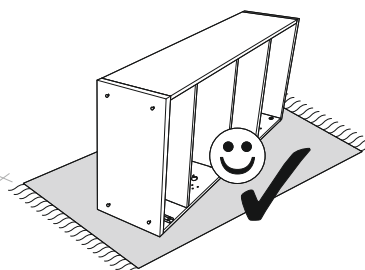
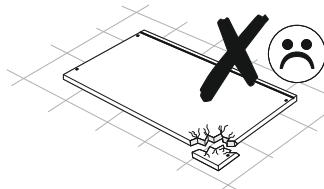
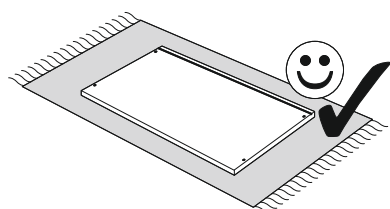
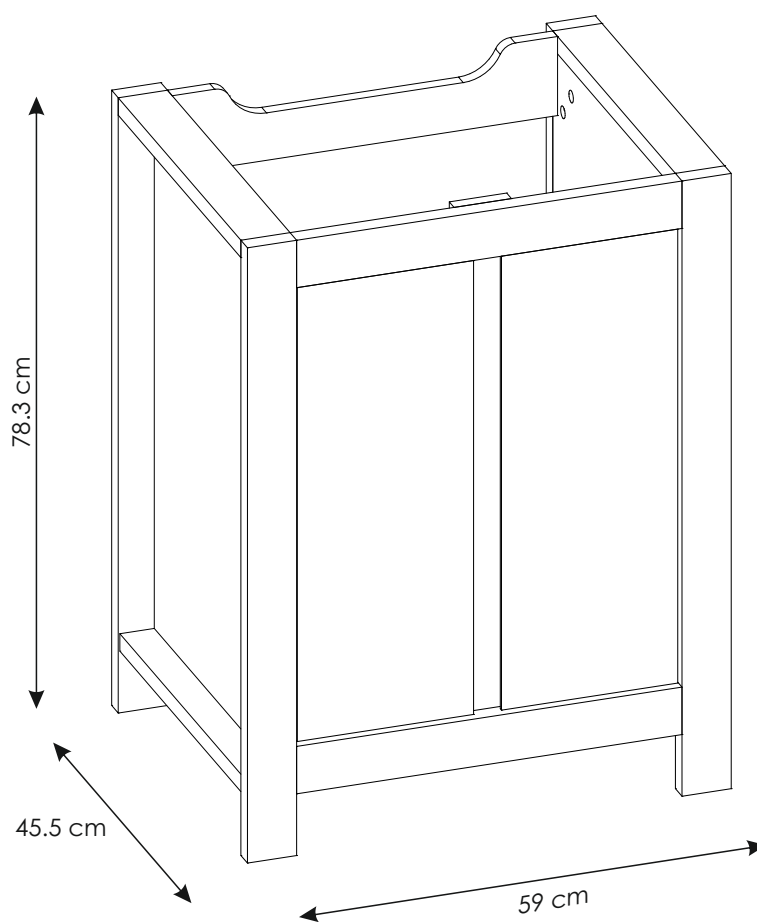
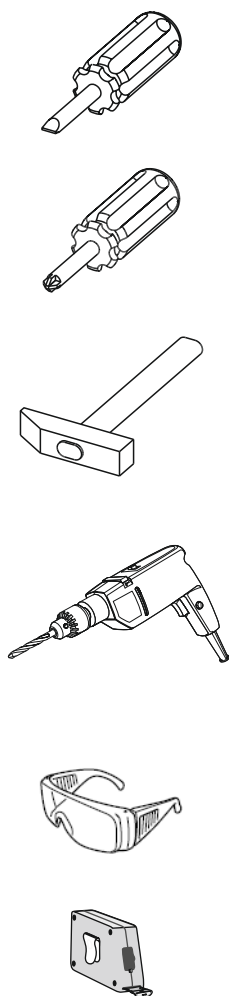
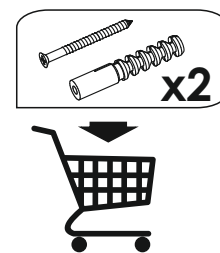
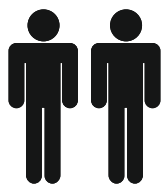

PL.

UWAGA! Mebel należy trwale zamocować do ściany, aby uniknąć ryzyka związanego z przewróceniem się mebla.

W paczce nie ma śrub mocujących, ponieważ rodzaj mocowania należy odpowiednio dobrać do rodzaju ściany. Dobierz właściwe do Twojego rodzaju ściany.

D.

ACHTUNG! Um alle mit dem Umkippen des Möbels verbundenen Risiken auszuschließen, muss das Möbel fest an der Wand verankert werden.

Beschläge für die Wandbefestigung sind nicht beige packt, da diese von der jeweiligen Wandbeschaffenheit abhängig sind. Bitte solche Befestigungschlöße wählen, die für die heimischen Wände geeignet sind.

FR.

ATTENTION! Ce meuble doit être fixé en permanence au mur pour éviter les risques de chute. Les vis de fixation ne sont pas livrées car le type de fixation doit être choisi en fonction du type de mur. Sélectionnez les fixations adaptées au mur.

I.

ATTENZIONE! Il mobile deve essere permanentemente fissato alla parete per evitare i rischi derivanti da un ribaltamento del mobile. La confezione non include le viti di fissaggio, in quanto il tipo di fissaggio deve essere scelto in base al tipo di parete. Utilizzare viti appropriate in base al materiale della parete.



HR.

NAPOMENA! Namještaj mora biti trajno pričvršćen za zid, kako bi se izbjegao rizik od njegovog prevrtanja. U paketu nema vijaka za pričvršćivanje, jer se vrsta montaže mora prilagoditi vrsti zida. Odaberite pravu vrstu prema Vašoj vrsti zida.

EN.

WARNING! To prevent this furniture from tripping over, fix it to the wall permanently. Fixing devices are not included since different wall materials require different types of fixing devices. Please make sure you chose the correct ones for your type of wall.

SK.

POZOR! Nábytok musí byť trvalo pripevnený k stene tak, aby sa zamedzilo riziku prevrátenia. Balík neobsahuje upevňovacie skrutky, pretože typ upevnenia je treba vybrať podľa typu steny. Vyberte typ vhodný pre Vašu stenu.

CZ.

POZOR! Nábytek je nutné pevně připevnit ke zdi, abychom se vyhnuli riziku spojenému s jeho převrnutím. Součástí balení nejsou připevňovací šrouby, protože způsoby připevnění je nutné zvolit podle druhu stěny. Vyberte správný pro Váš typ stěny.

RO.

Atentie! Pentru a exclude posibilitatea ca mobilierul sa se rasptoarne, va rugam sa il fixati in perete. Elementele de fixare nu sunt incluse in pachet, deoarece diferitele tipuri de materiale folosite pentru realizarea peretilor necesita elemente de prindere specifice acestora. Va rugam sa va asigurati ca alegeti corect elementele de prindere pentru perete.

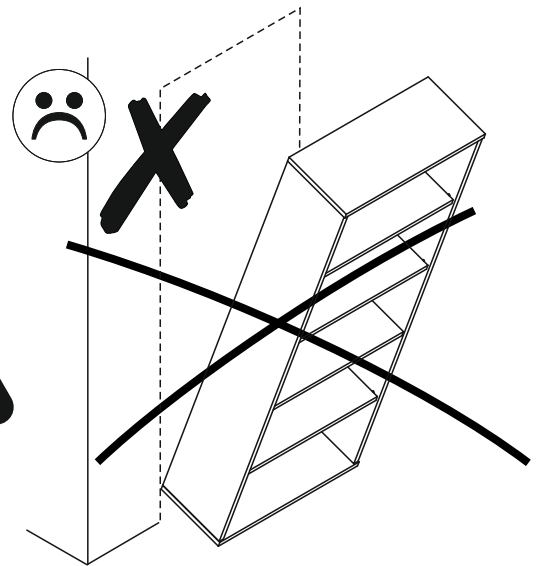

E.

¡ATENCIÓN! El mueble debe ser fijado permanentemente a la pared para evitar el riesgo relacionado con el vuelco del mueble. En el paquete no hay tornillos de fijación, ya que se debe elegir el tipo de fijación adecuado para el tipo de pared. Elija el apropiado para su tipo de pared.

CN.

注意！本家具需要固定在墙上以免倒塌。箱子里没有安装螺钉。因为安装方式需要根据墙的类型调整。请按照您的墙类型选择合适的安装方式。

RU.

ПРИМЕЧАНИЕ! Эту мебель необходимо всегда прикреплять к стене, чтобы избежать рисков, связанных с переворотом мебели. В пакете нет крепежных винтов, потому что тип крепления должен быть выбран в соответствии с типом стены. Выберите, пожалуйста, правильные винты к вашей стене.

SLO.

POZOR! Pohištvo trajno pritrdite na steno, da preprečite tveganje, da se prevrne. V paketu ni pritrilnih vijakov, saj je treba način pritrditve ustrezno izbrati glede na vrsto stene. Izberite način, ki je ustrezen za vašo steno.









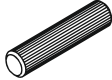
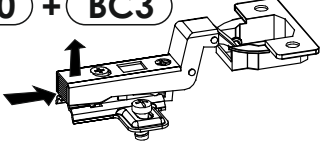

HU.

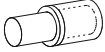
FIGYELEM! Rögzítse a bútorokat a falhoz, hogy elkerülje a bútor felborulásának kockázatát. A készletben nem található rögzítőcsavarok, mivel a rögzítés típusa a fal típusától függ. Válassza ki a fal típusának megfelelő kötőelemeket.

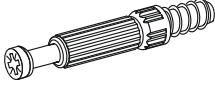

CLASSIC 820

MM

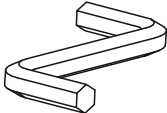
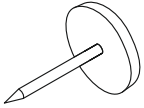
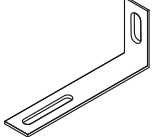
A1 8 x 35 mm x20 	A2 8 x 45 mm x2 	BC0 + BC3 x4 
C1 4 x 13 mm x8 	D2 x4 	E0 x26 
E1 15 x 12 mm x26 	F1 6 x 34 mm x22 	F3 7 x 62 mm x2 
G0 x4 	G1 7 x 50 mm x4 	I2 4 x 16 mm x2 
I5 4 x 35 mm x4 	M x1 	O2 x4 
Q9 x2 		

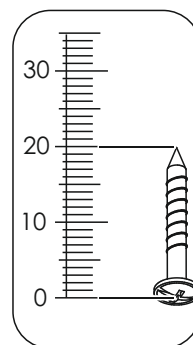
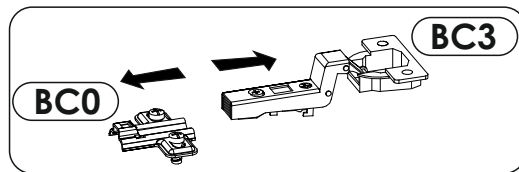
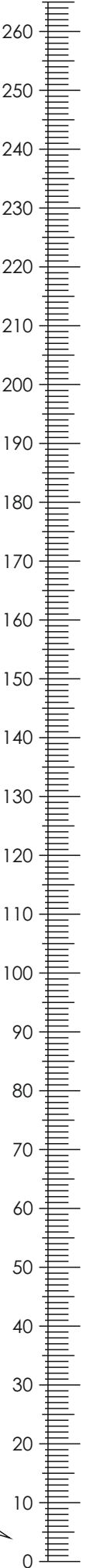

CLASSIC 820

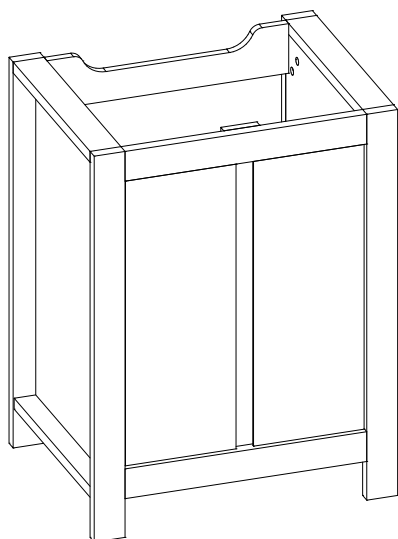

1	656	411	16	x1	1/1
2	678	70	16	x1	1/1
3	656	411	16	x1	1/1
4	411	60	22	x2	1/1
5	470	390	16	x1	1/1
6	586	411	22	x1	1/1
7	470	100	16	x1	1/1
8	470	100	16	x1	1/1

9	470	60	22	x1	1/1
10	778	60	22	x1	1/1
11	778	60	22	x1	1/1
12	778	60	22	x1	1/1
13	778	60	22	x1	1/1
14	574	215	16	x2	1/1
15	470	60	22	x1	1/1

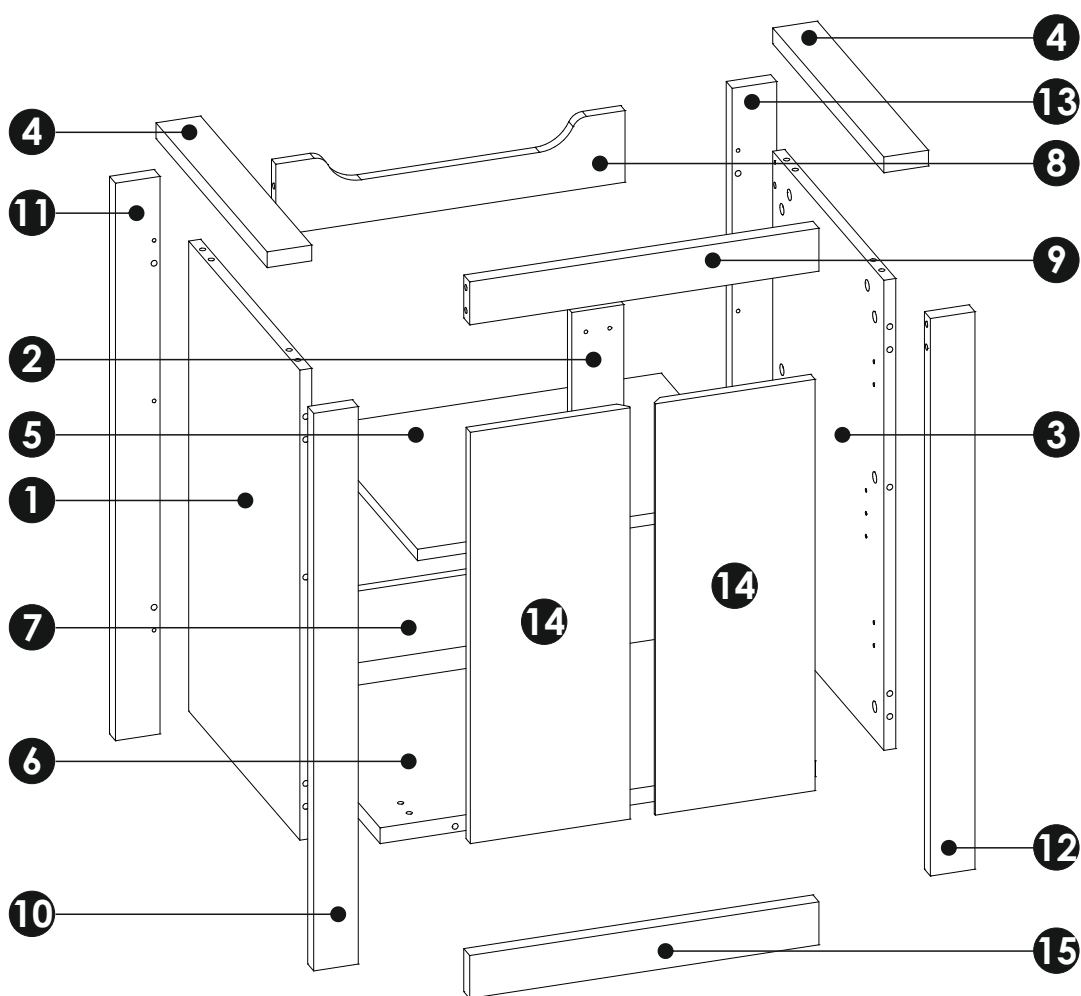



1 ▶

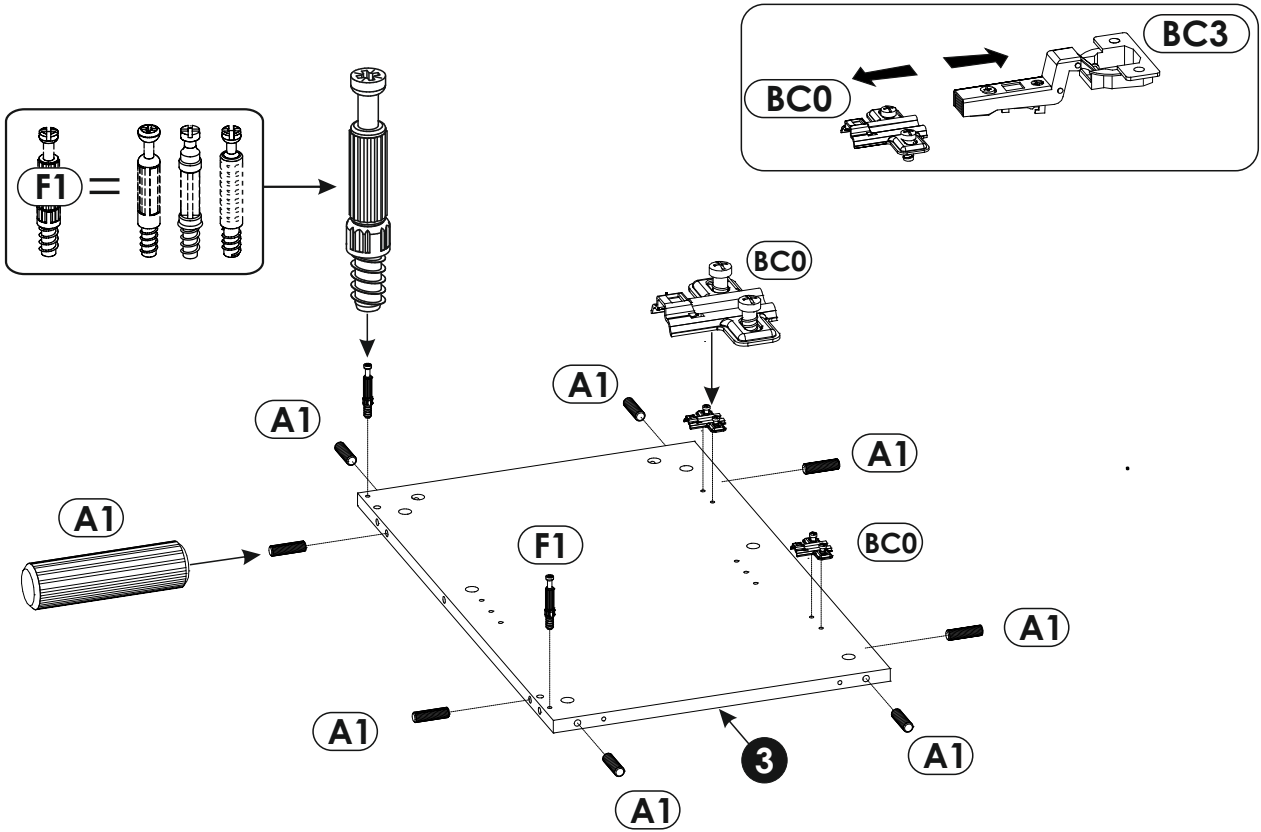

2 ▶

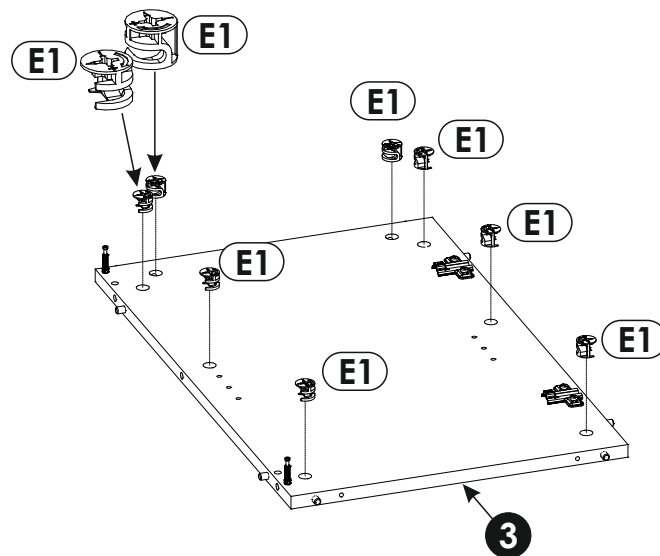

3 ▶

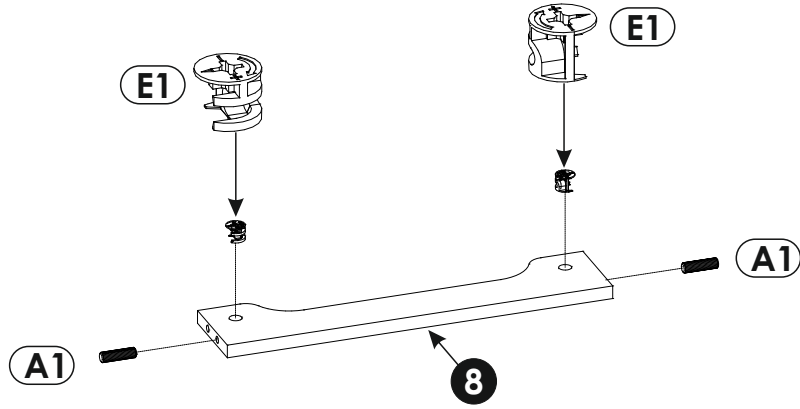

4 ▶

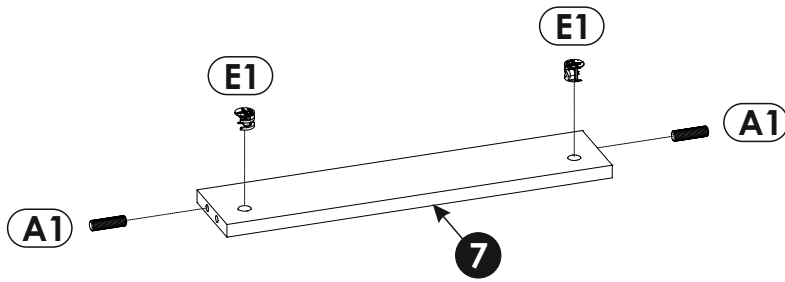

5 ▶

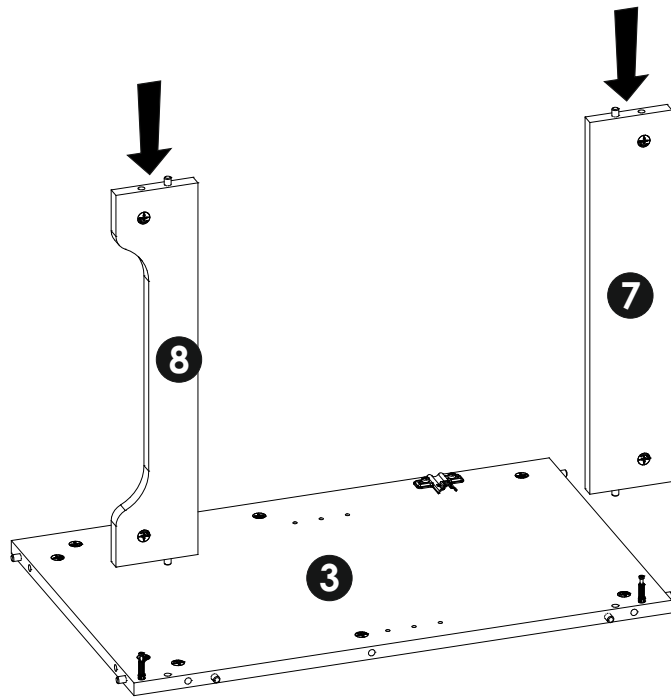
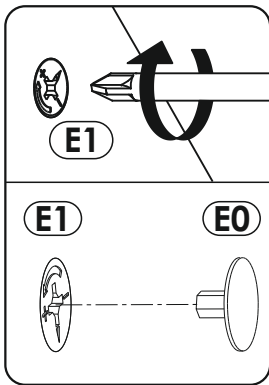
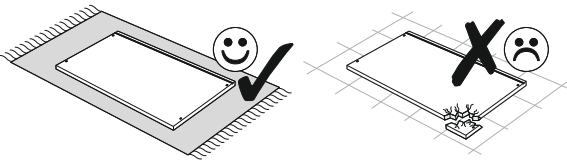

6 ▶

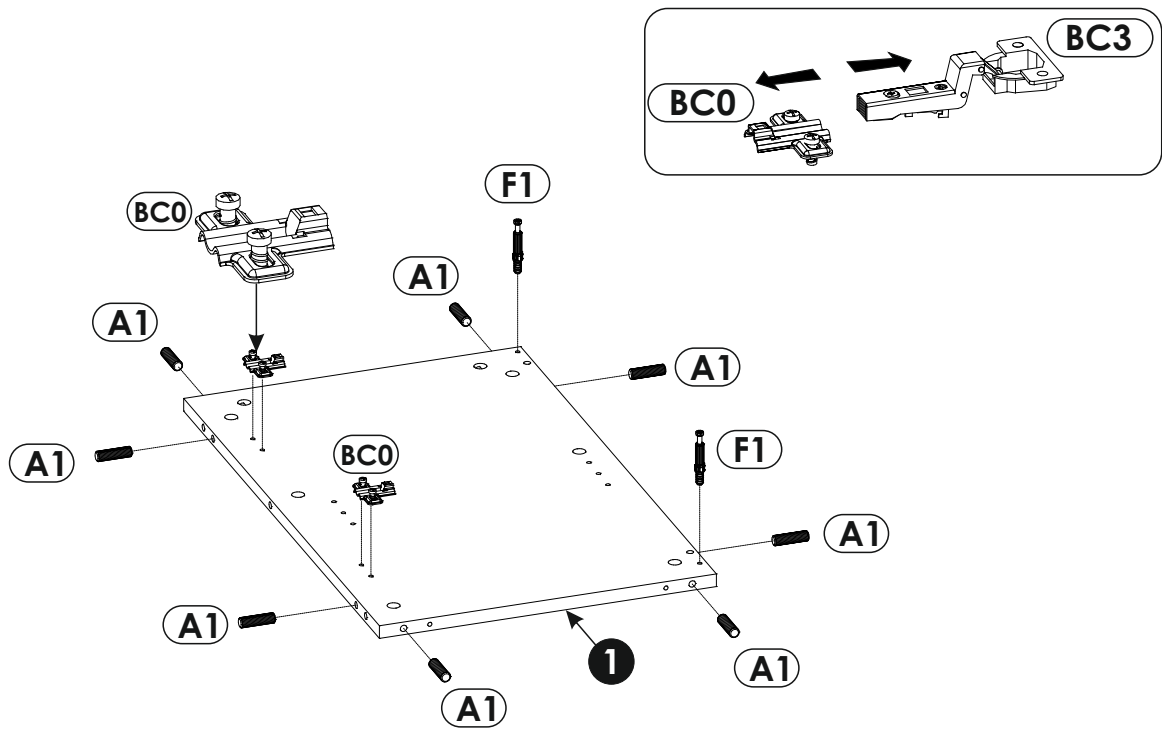

7 ▶

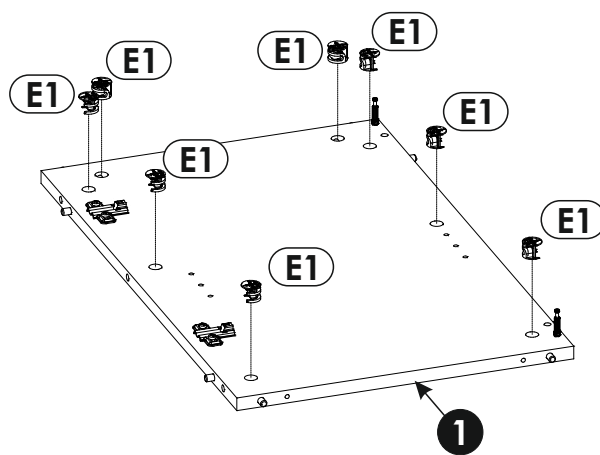

8 ▶

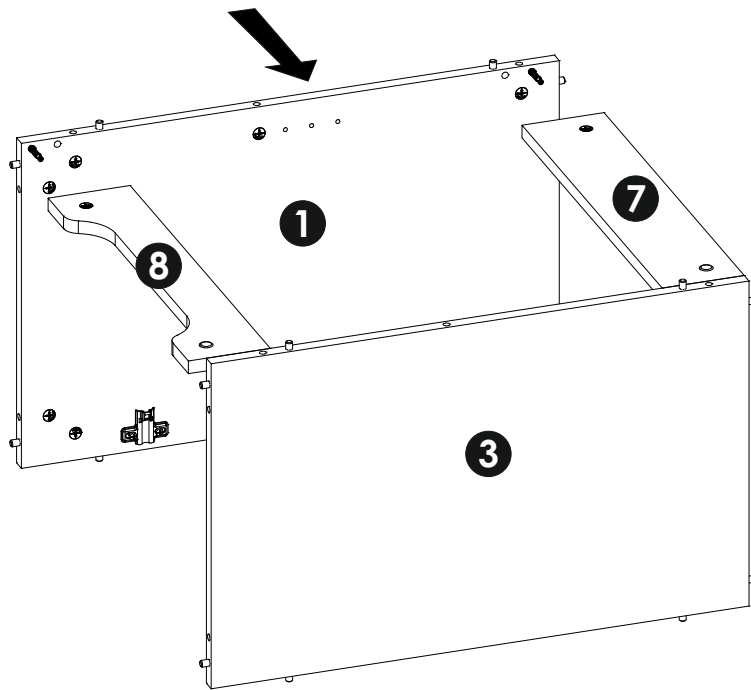
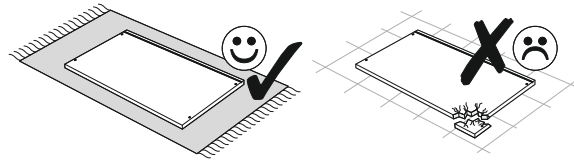
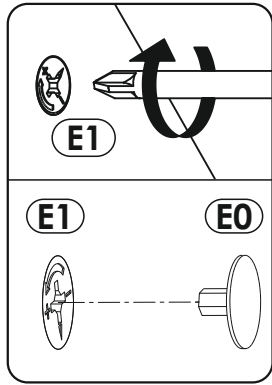

9 ▶

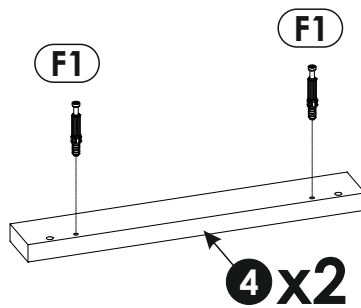
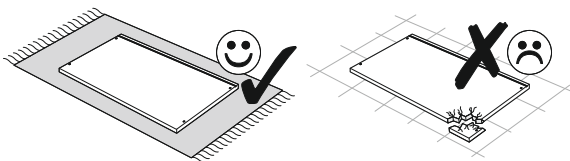

10 ▶

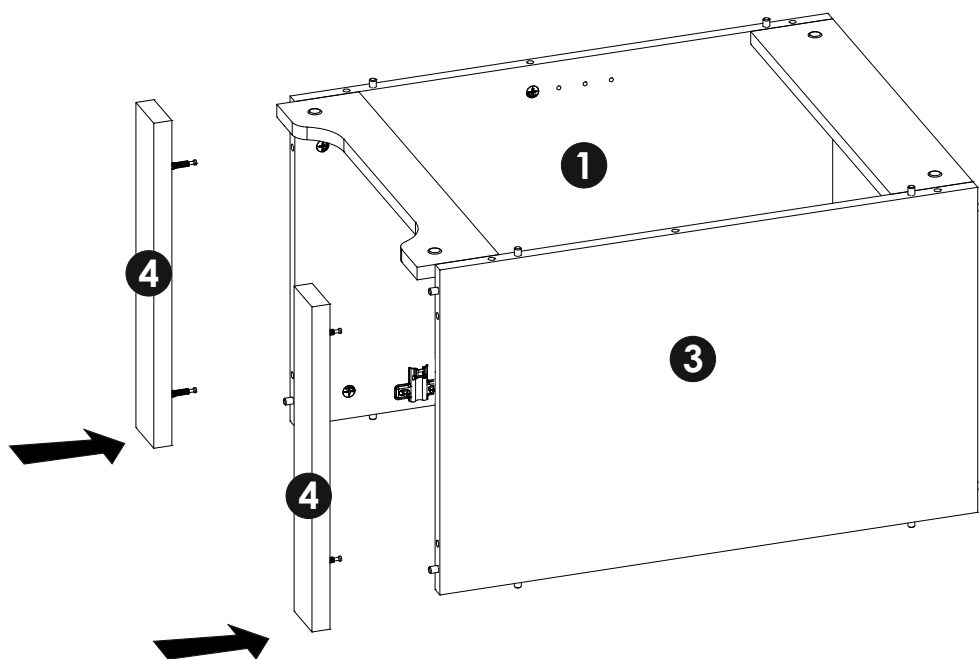
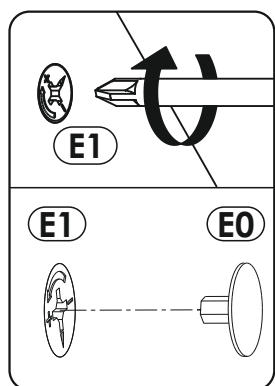
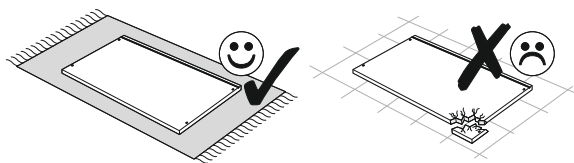

11 ▶

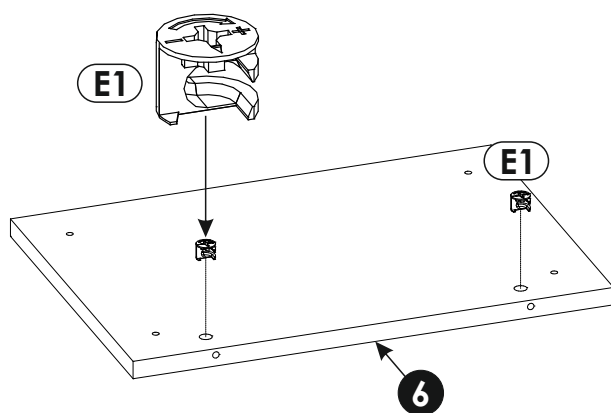

12▶

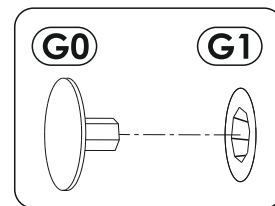
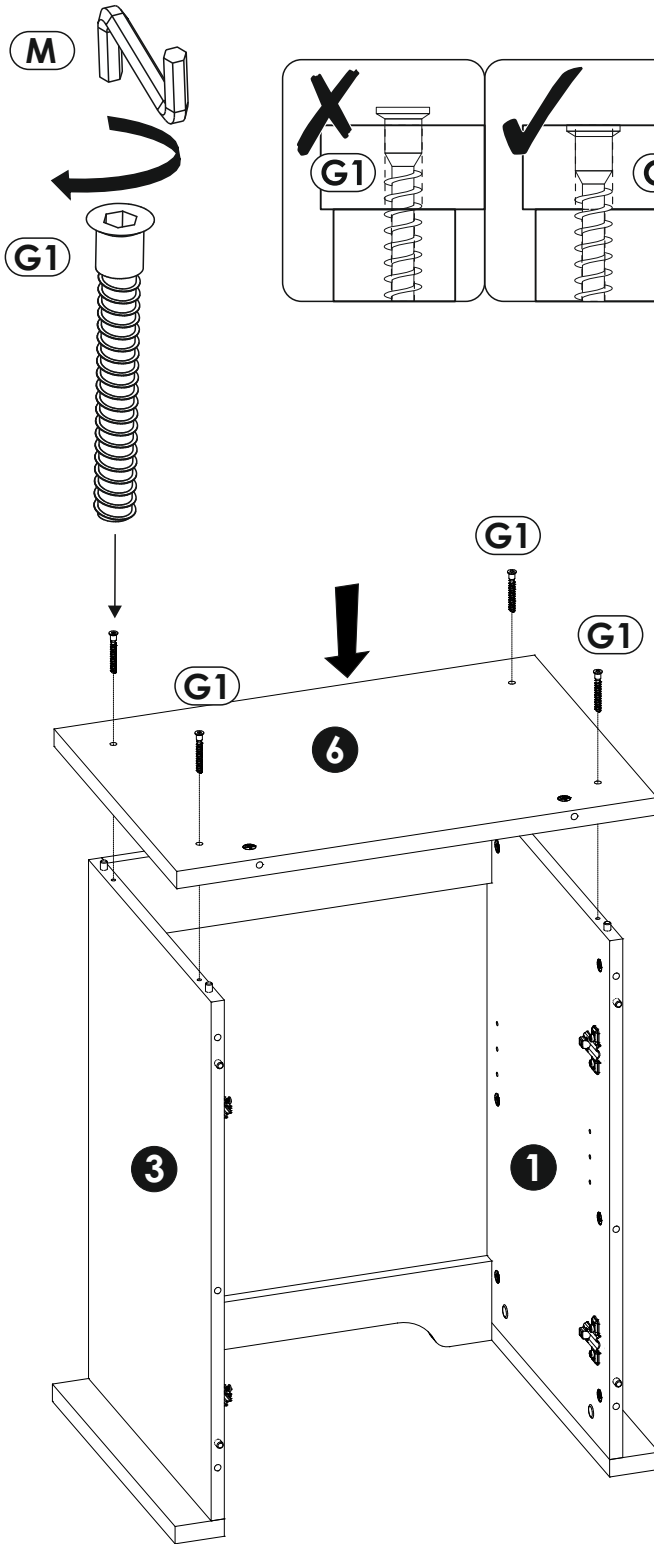
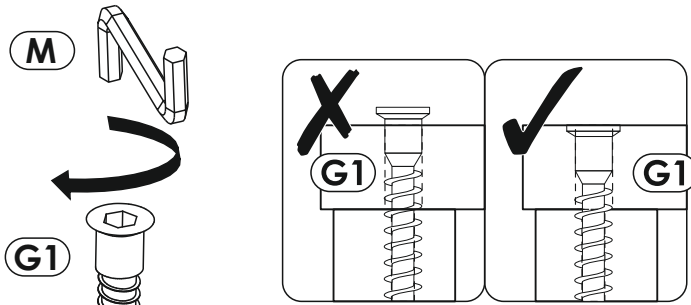
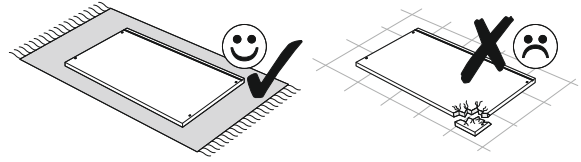

13 ▶

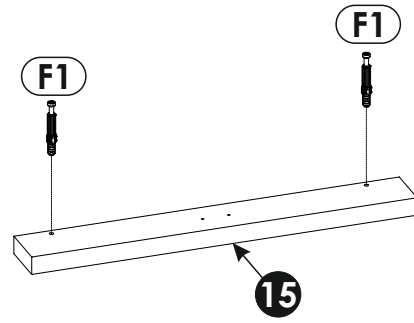
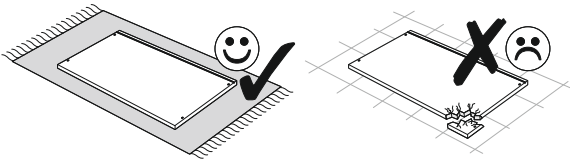

14 ▶

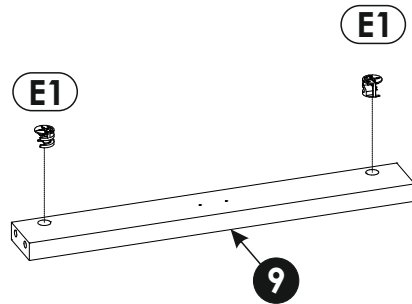
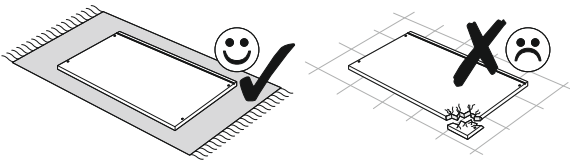

15 ▶

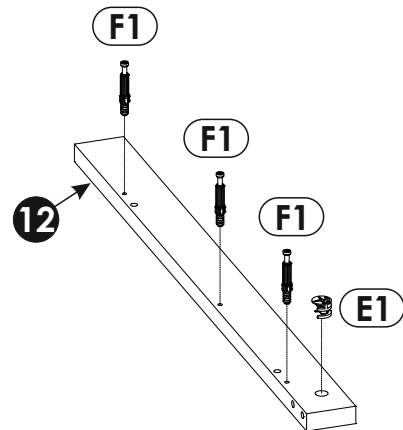
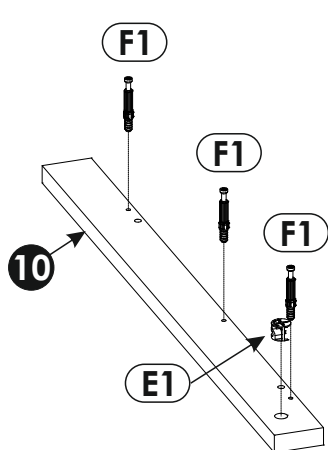
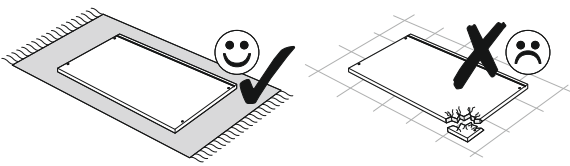

16 ▶

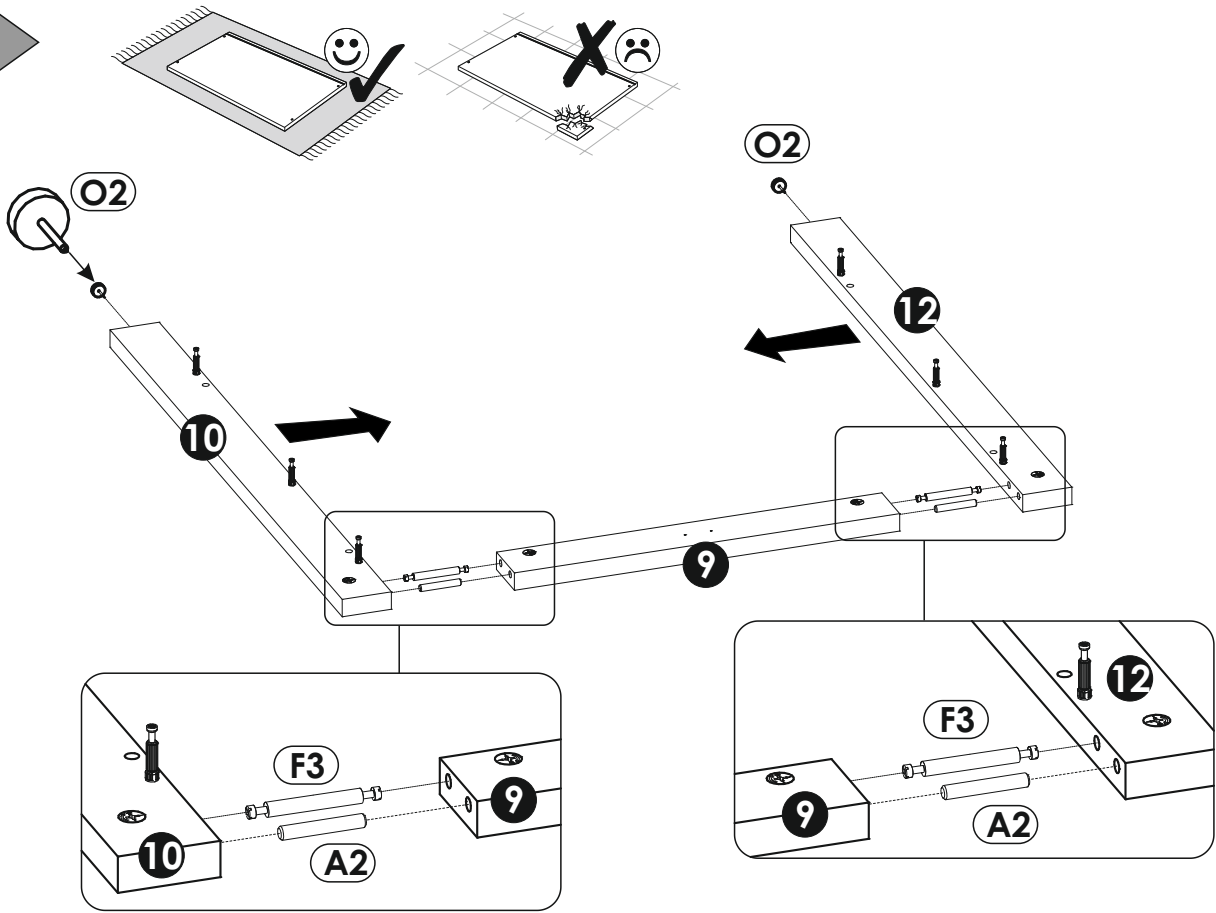

17 ▶

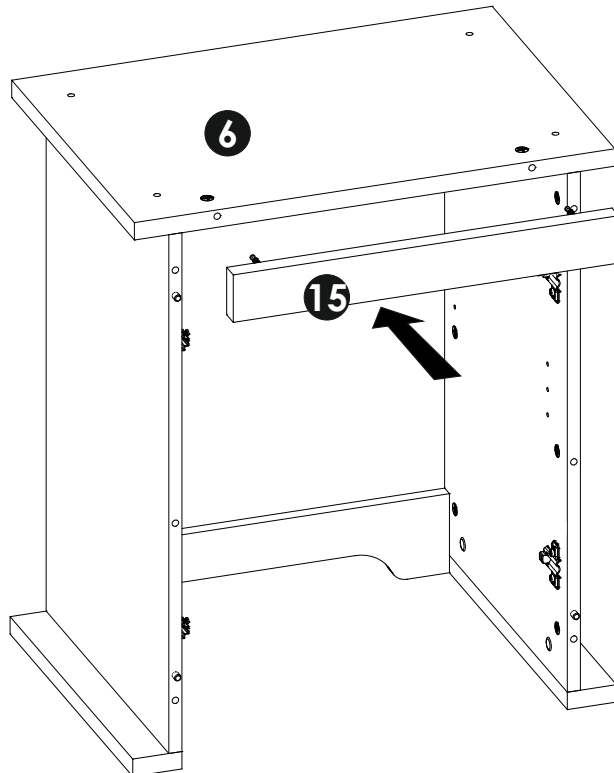
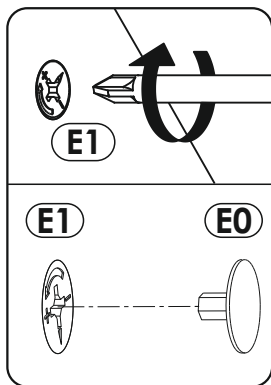
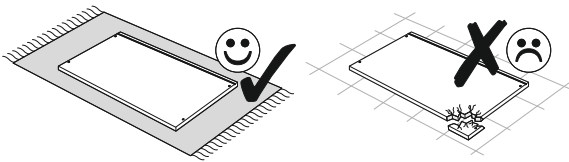

18▶

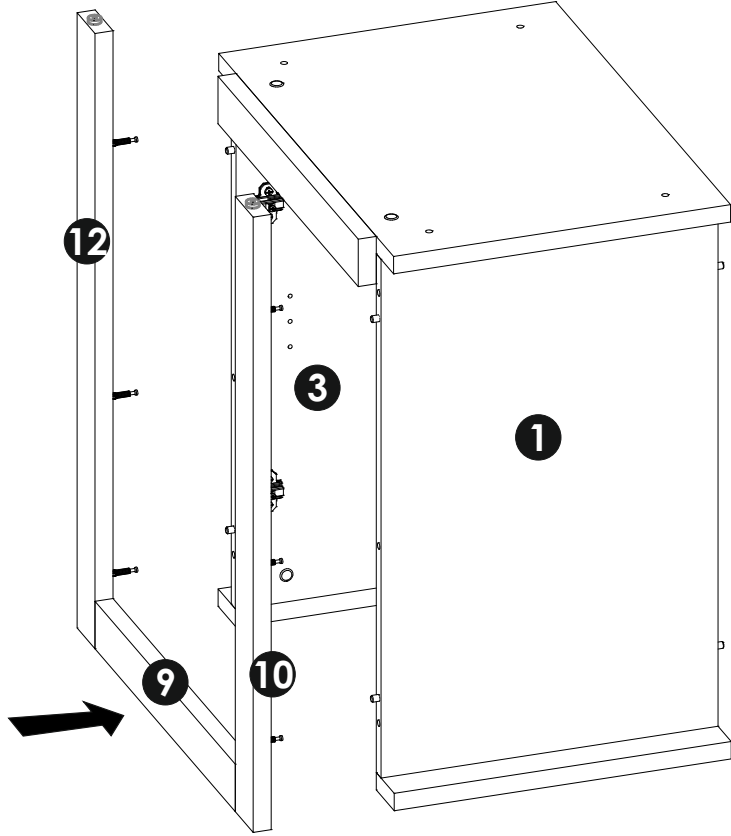
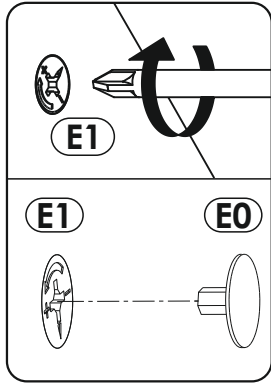
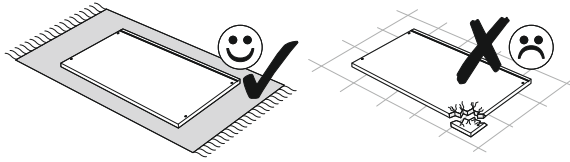

19▶

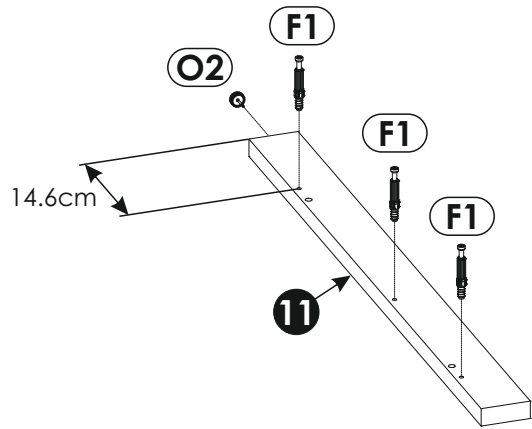
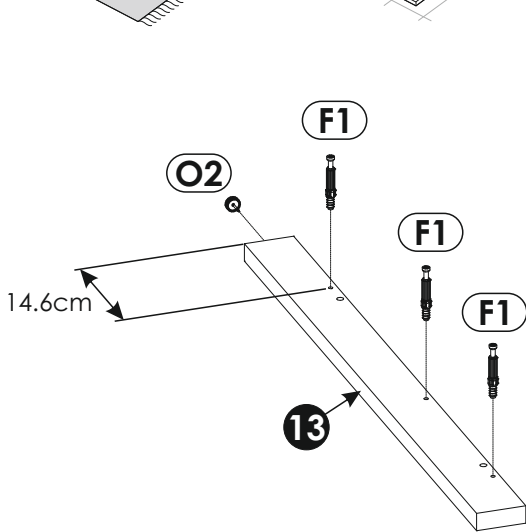
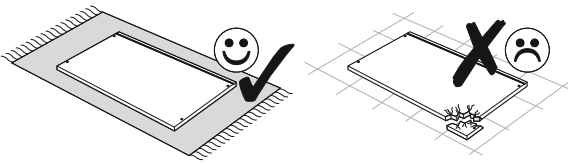

20 ▶

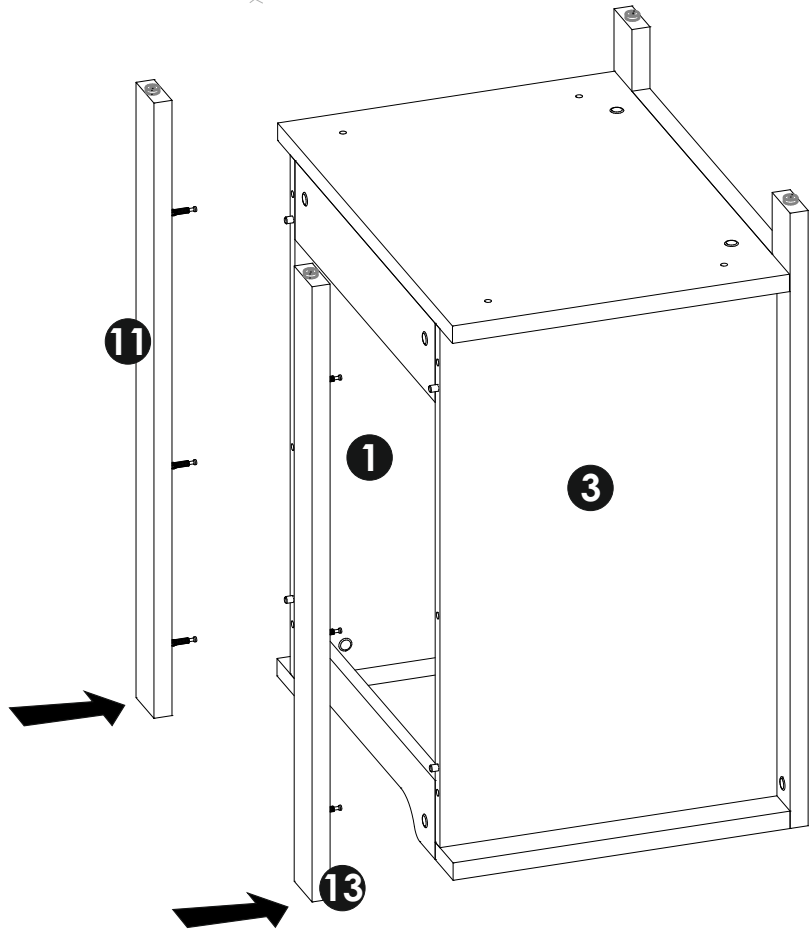
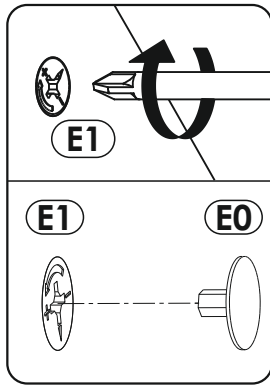
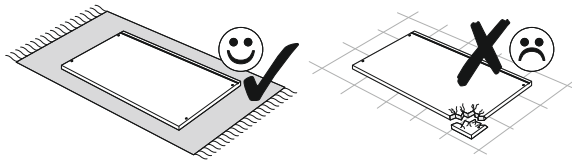

21 ▶

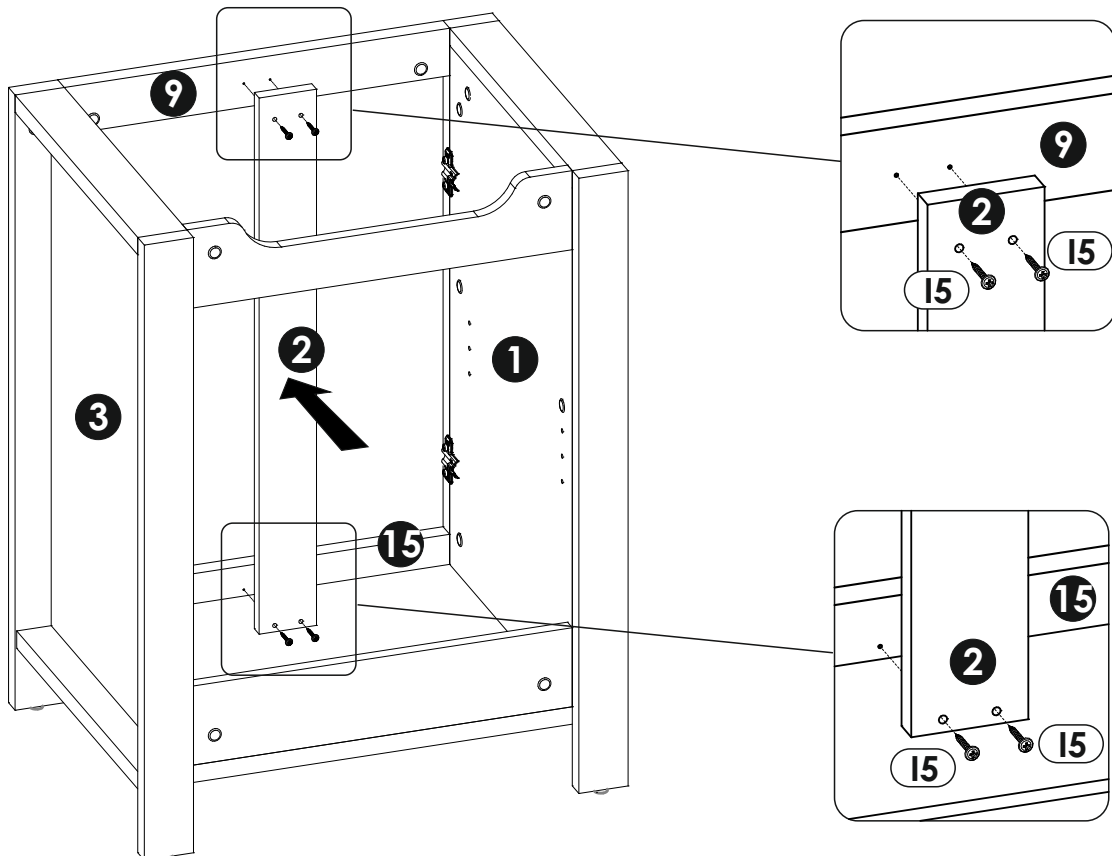

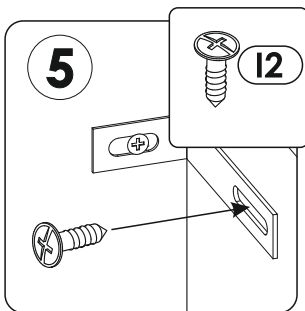
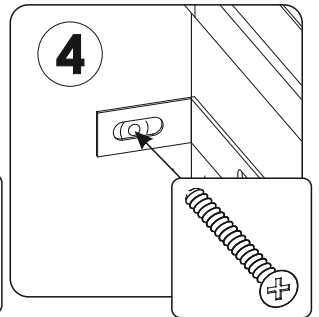
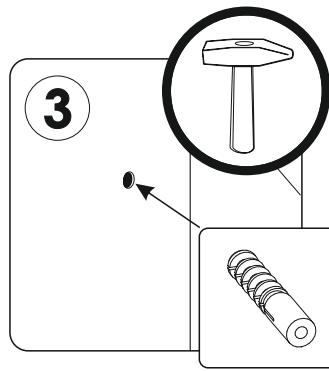
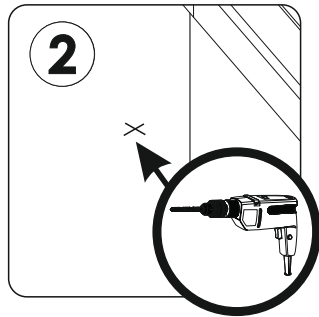
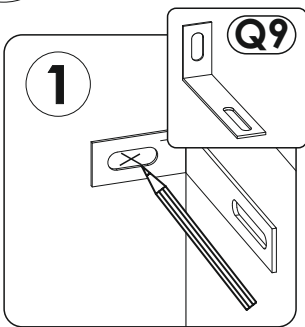
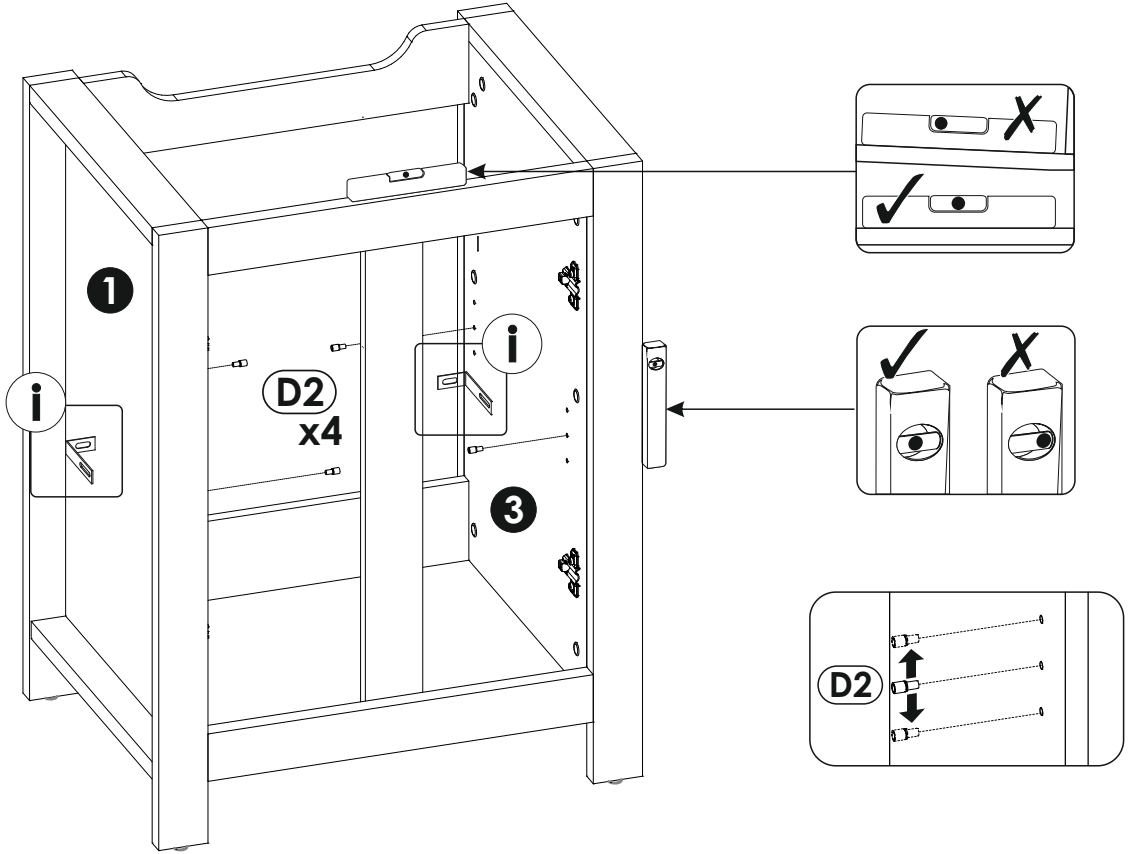
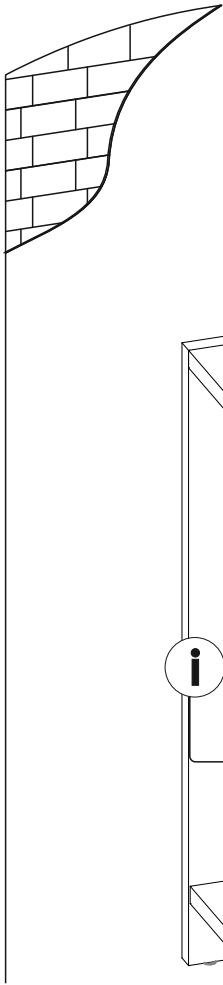
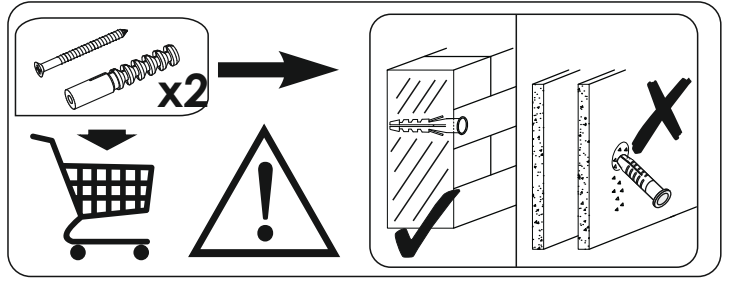

23 ▶

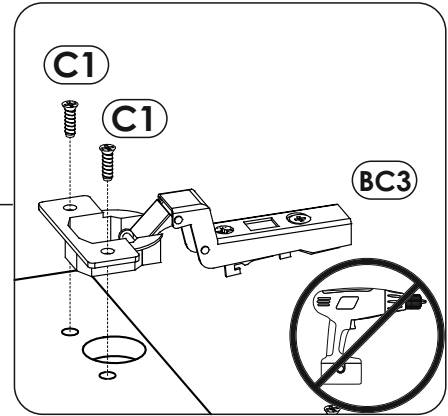
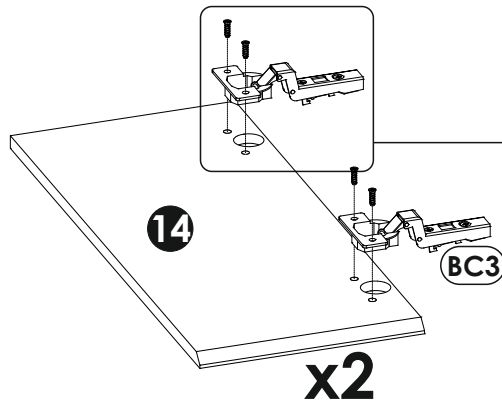
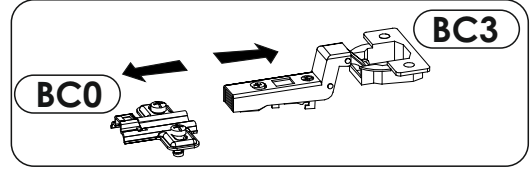
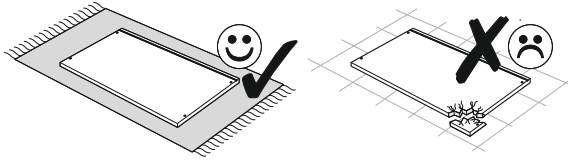

24 ▶

