



GB Assembly instructions

DE Montageanleitung

FR Notice de montage

NL Handleiding voor de montage

IT Istruzioni di montaggio

HU Szerelési útmutató

ES Instrucciones de montaje

PL Instrukcja montażu

CZ Montážní návod

SK Návod na montáž

HR Montaže

TR Montaj talimat

RO Instrucțiuni de montaj

RU Инструкция по монтажу

szynakameble

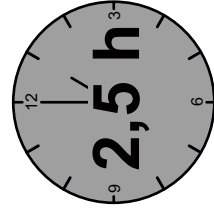
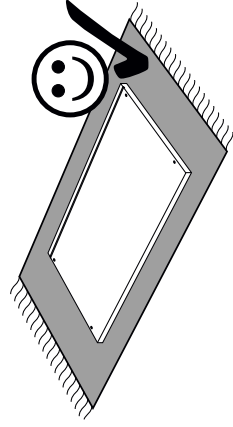
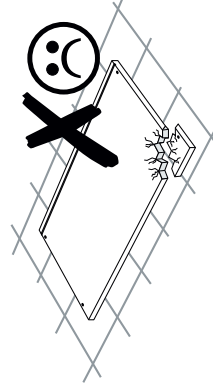
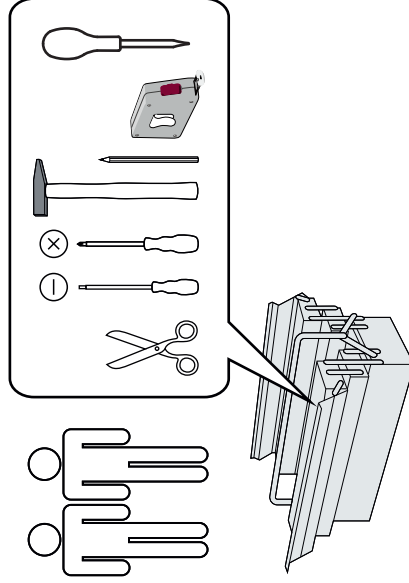
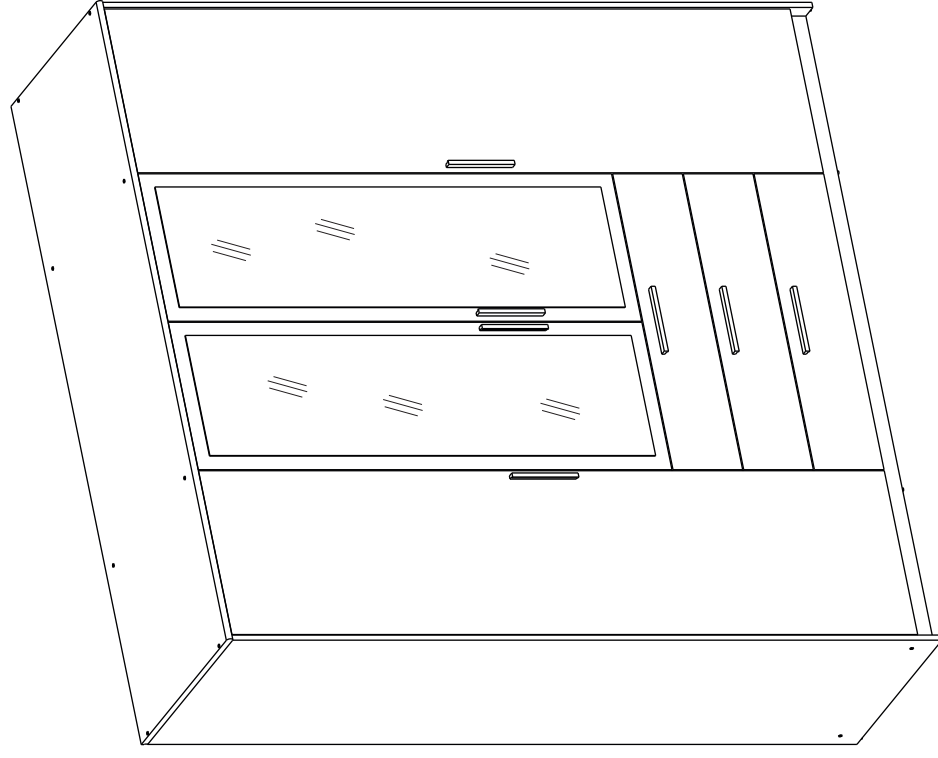

Service • Assistenza • Dienstverlening • Servis
Servis • Szerviz • Servizio • Usluga • Сервисная Служба

Name • NOME • Naam • Nazwa
 Jméno • NÁZOV • Név • Denimire
 Nombre • IME • Isim • Название

Nr. • No. • N° • Номер • Č. • Sz. • Ne
 Тип • Type • Tip • Tipus • Тип • Тип

MILO 02

shop • geschäft • boutique • sklep • winkel • магазин
 negozio • bolt • tienda • obchod • dućan • mağaza • magazin

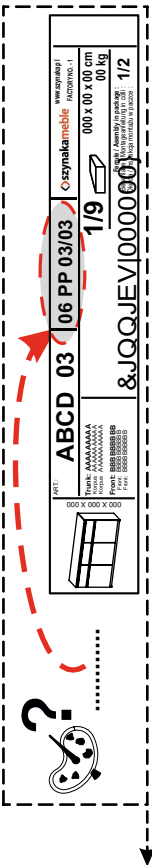
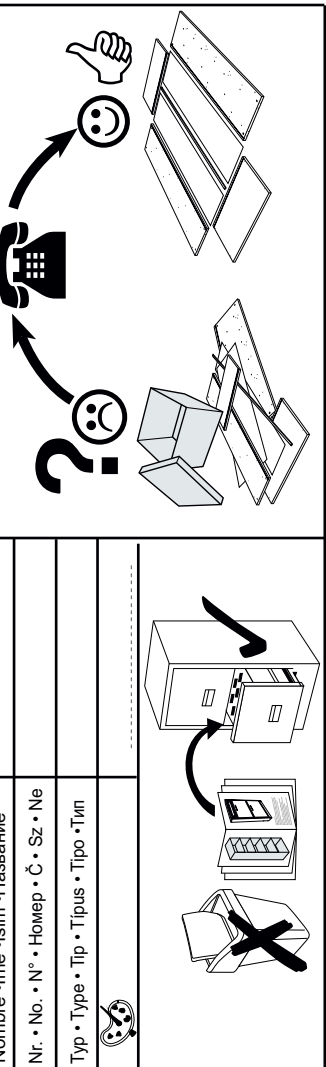

ABC D 03 06 PP 03/03 1/9
 &JQQJEVJ000000

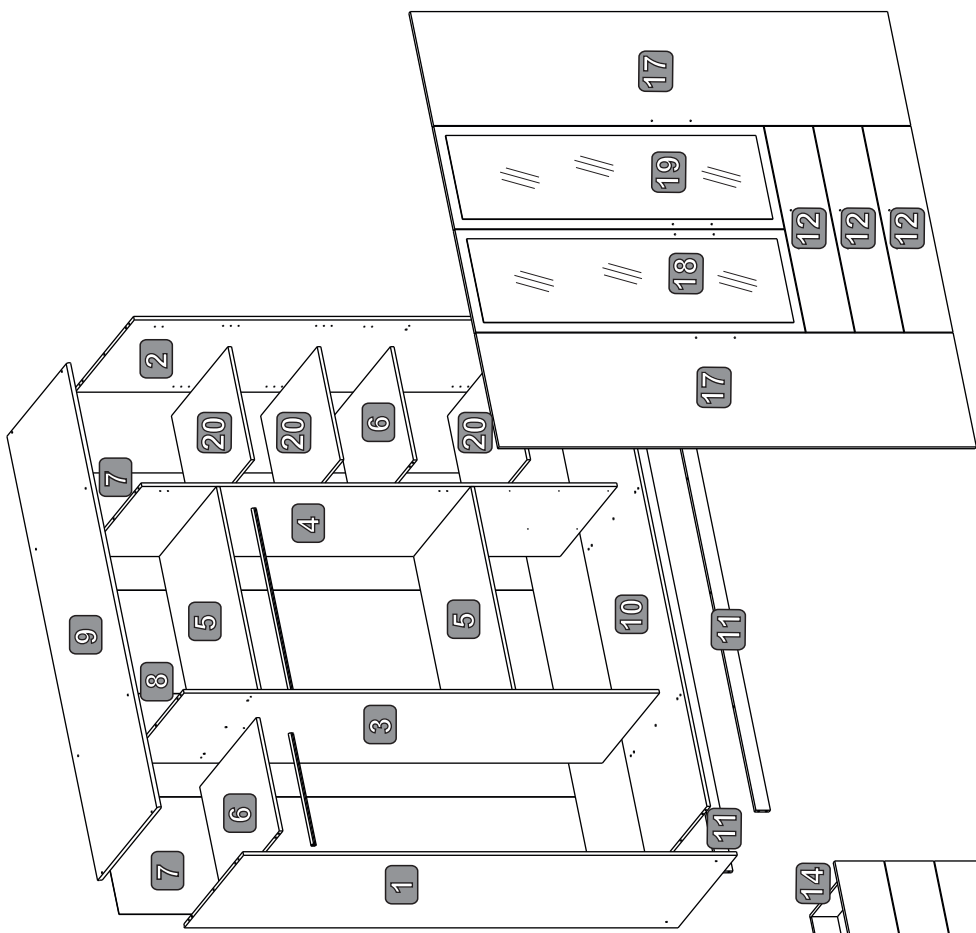

7x50 16X W01	Z01 4 X	Z02 10 X	3,5x15 20 X W01	4x25 14 X W03
3,5x13 24X W02	P01 3X L+P	R 12X	U01 7 X	L01 1X
T01 16 X	K01 1X	E01 12X	U01 7 X	L01 1X
T02 16X	G01 70 X	E03 4X	R 12X	T 1X
8x28 86X D01	S01 8 X	L-469 mm L-847 mm 2X J01	R 12X	T 1X
C01 16 X	S01 8 X	L-469 mm L-847 mm 2X J01	R 12X	T 1X

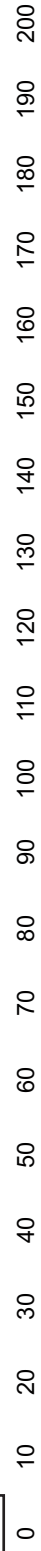
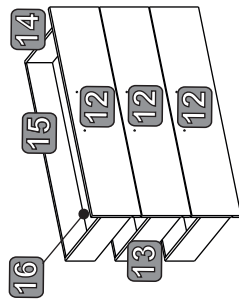

1

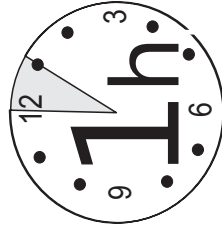
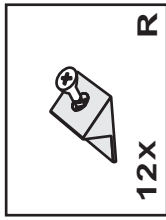
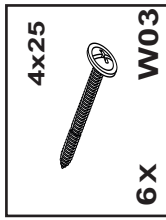
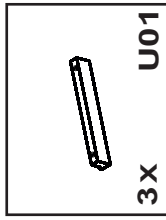
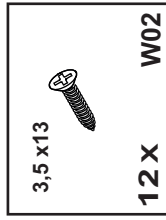
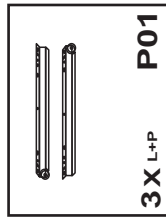
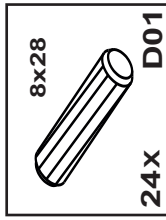
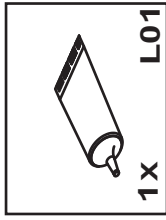
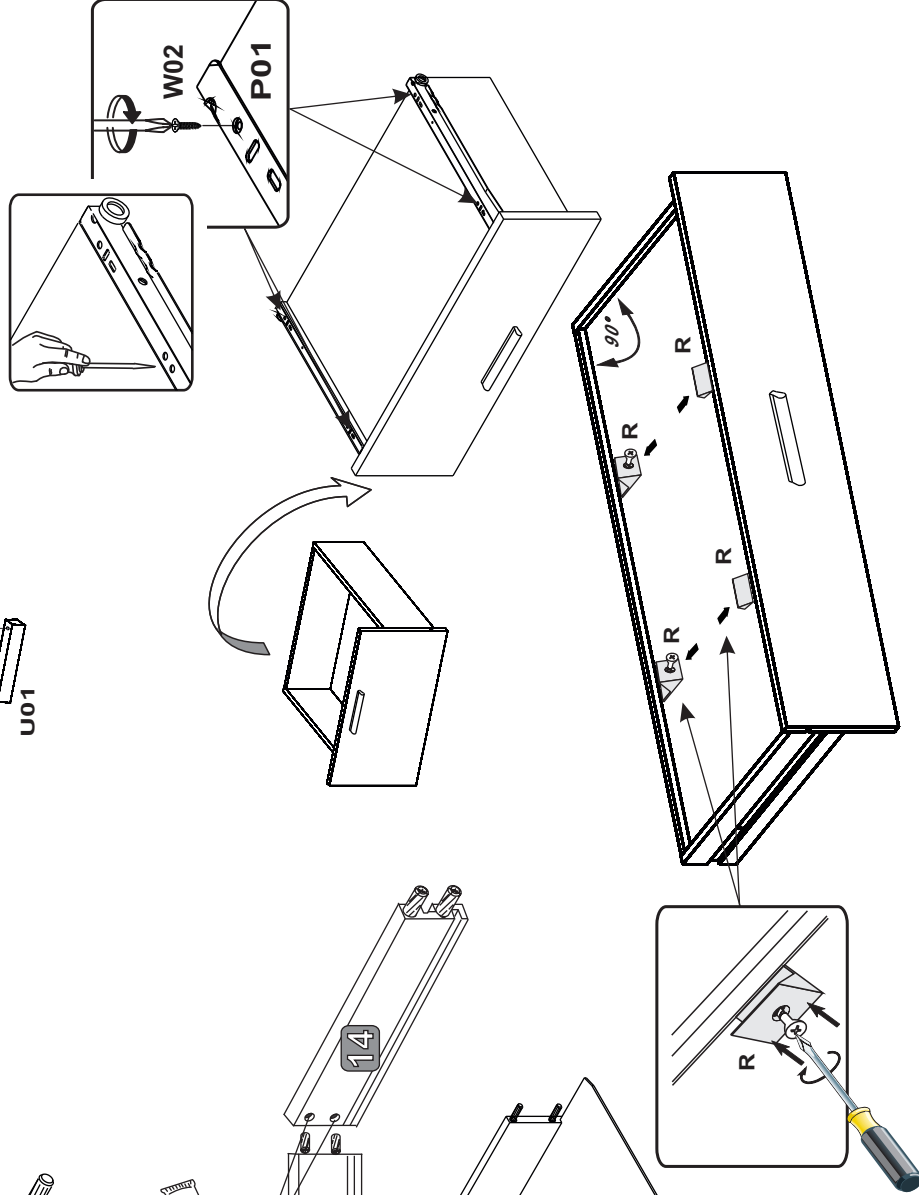
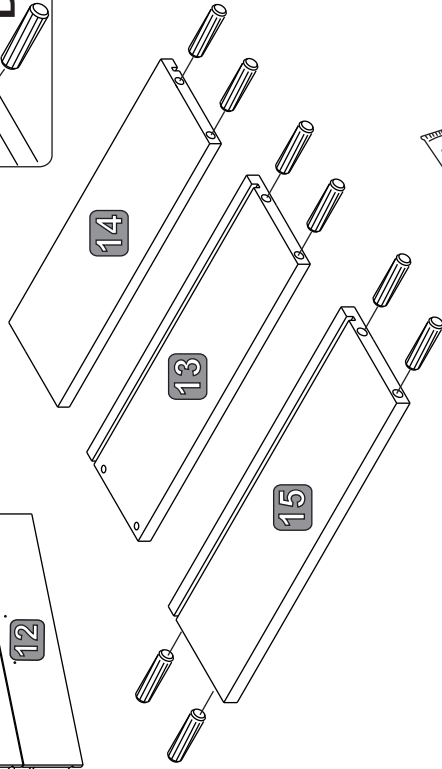
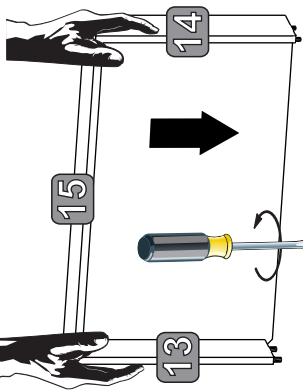
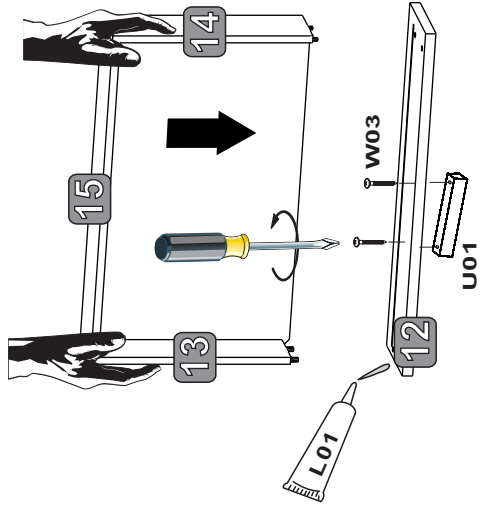
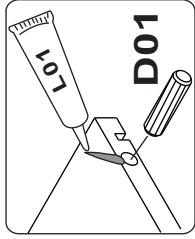
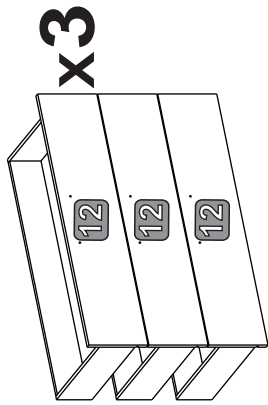

2

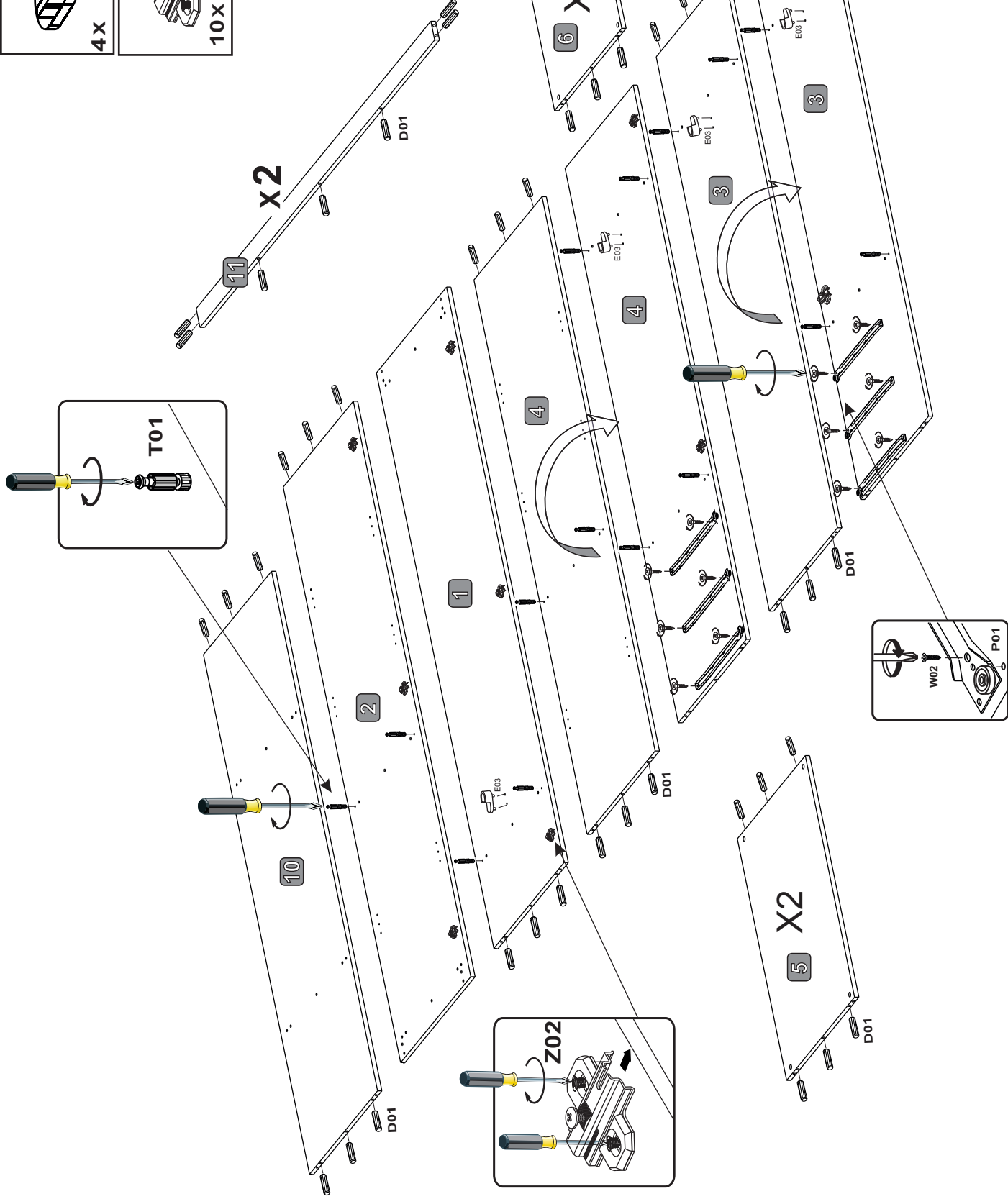
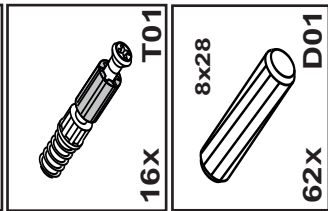
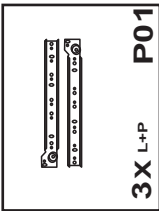
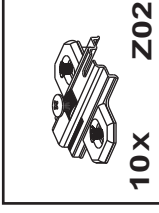
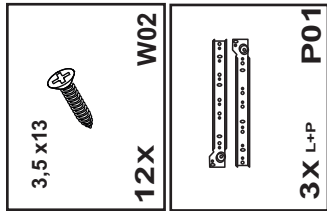
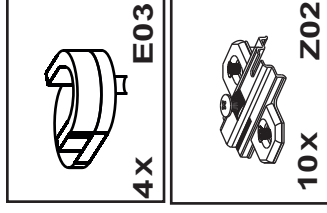

3

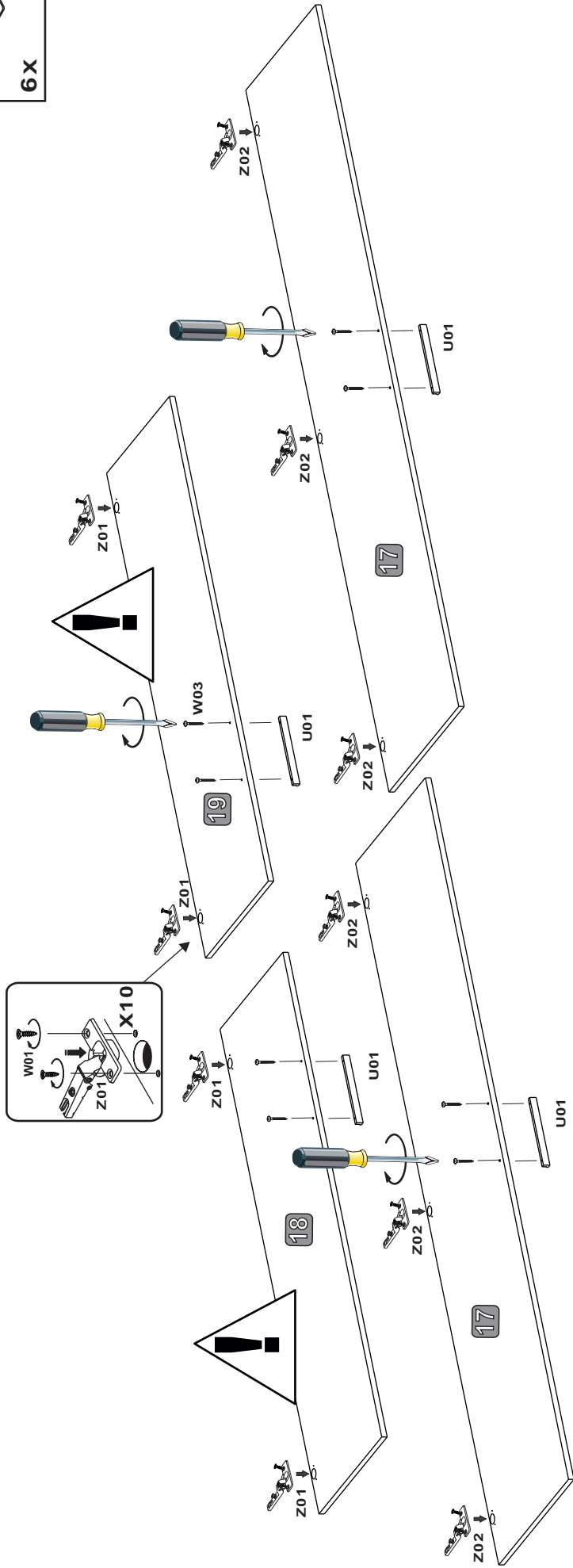
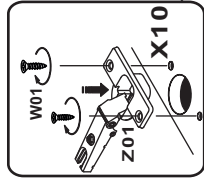
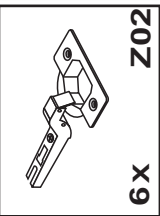
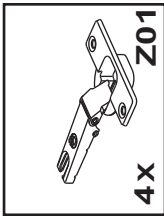
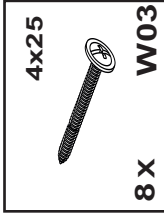
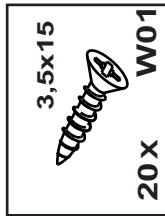
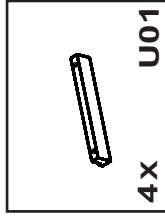

4

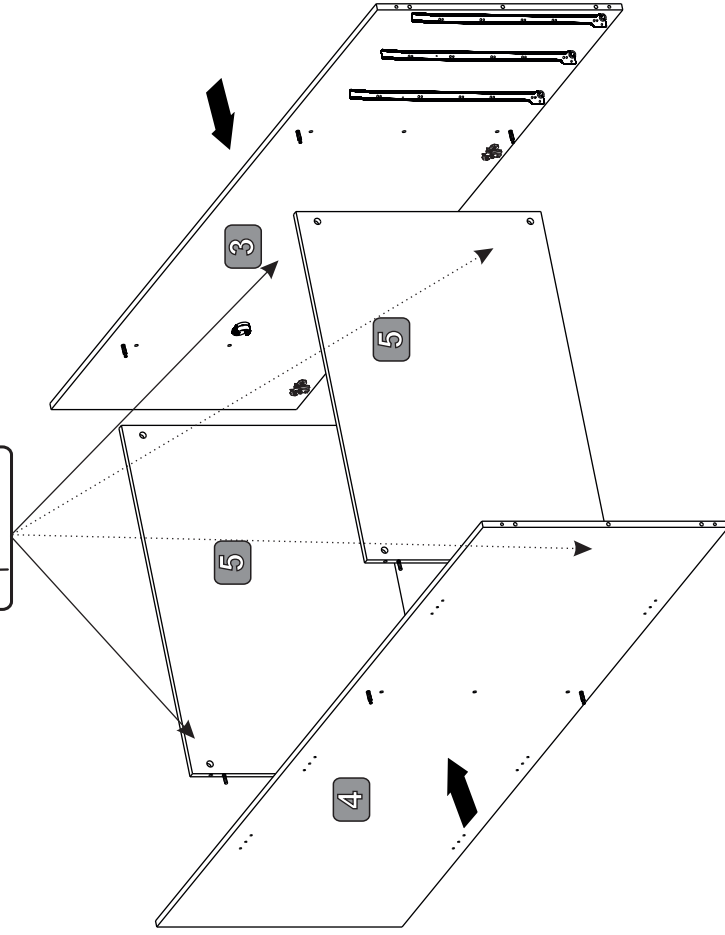
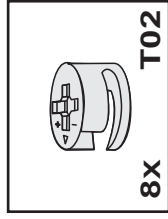
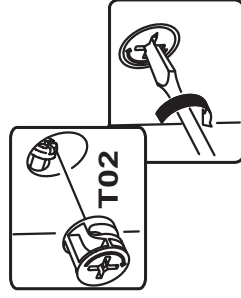

5

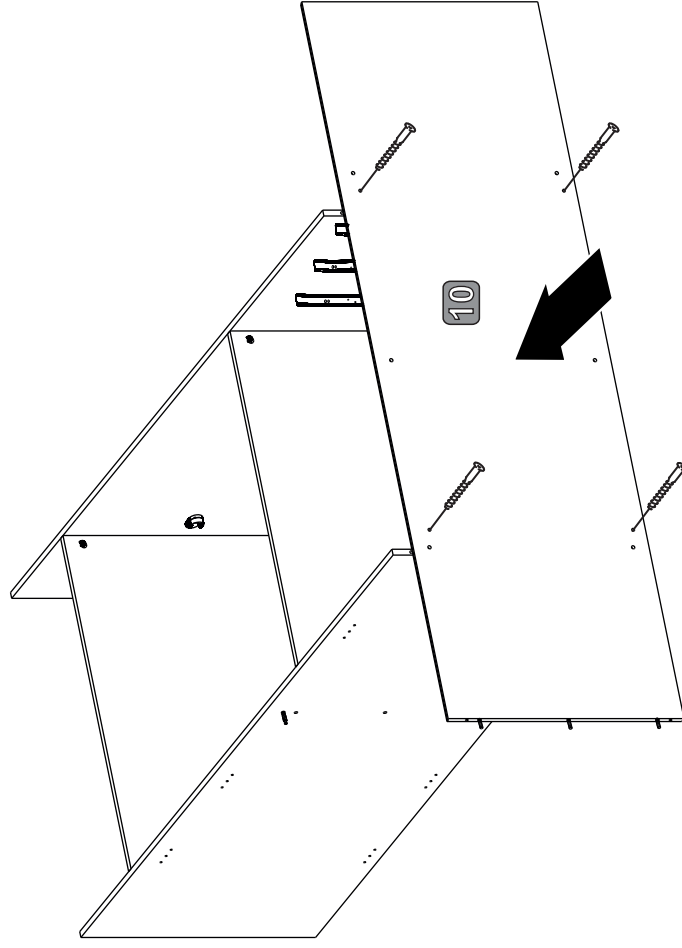
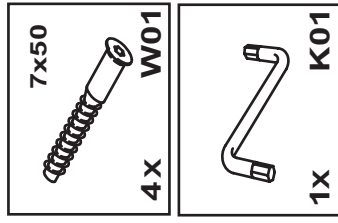

6

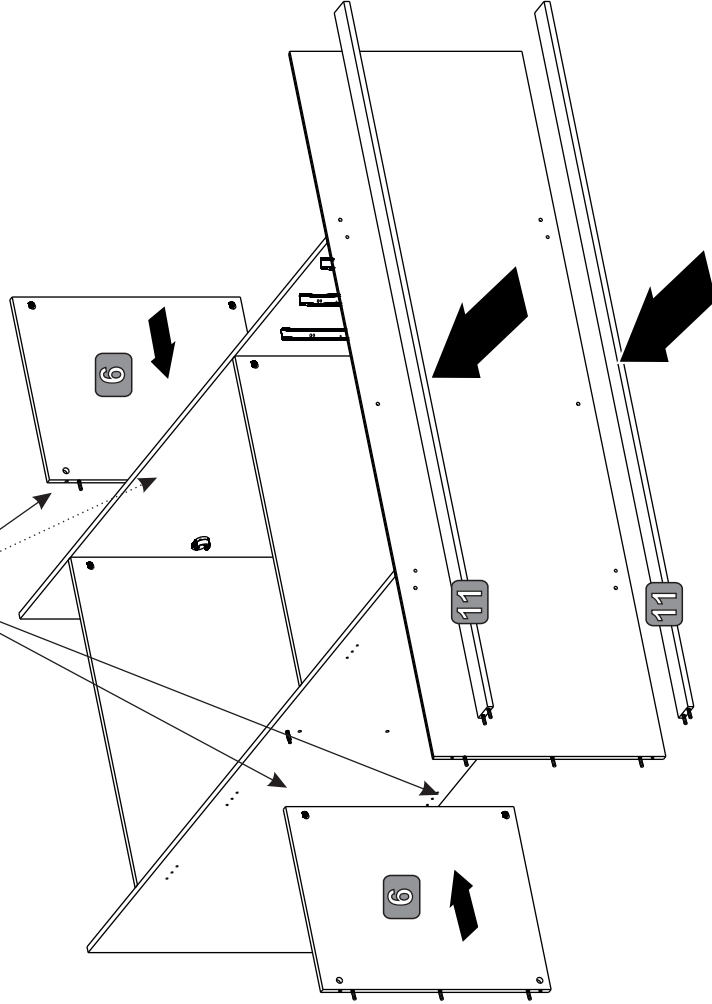
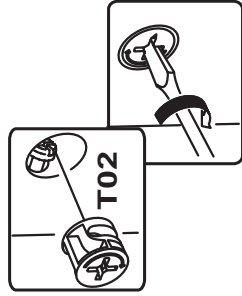
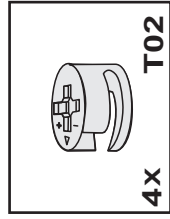

7

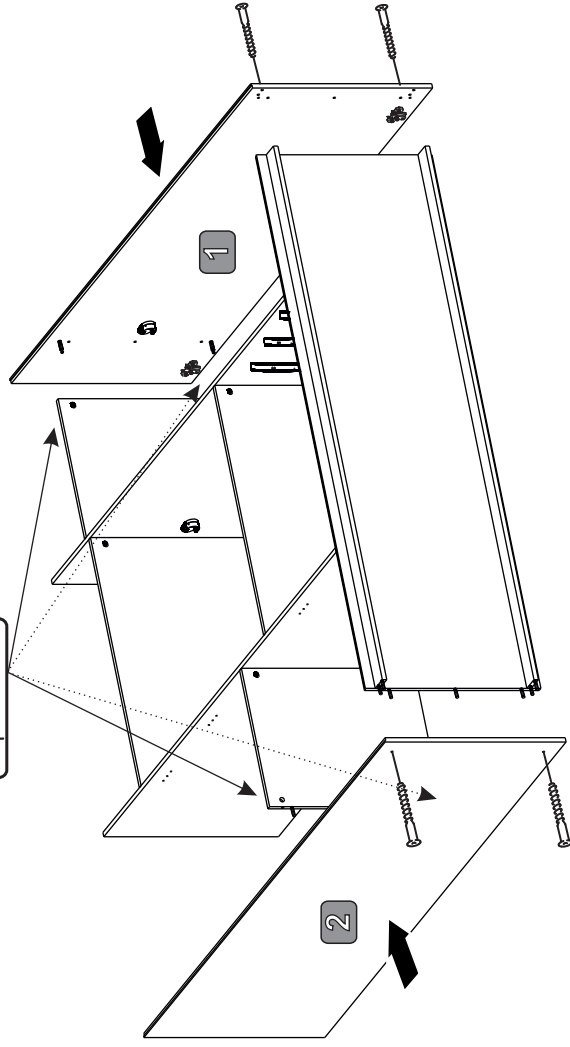
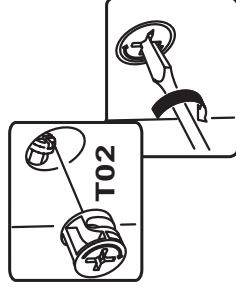
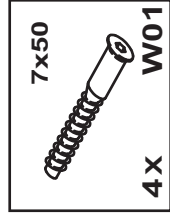
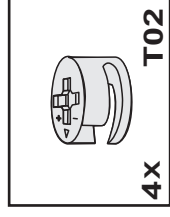

8

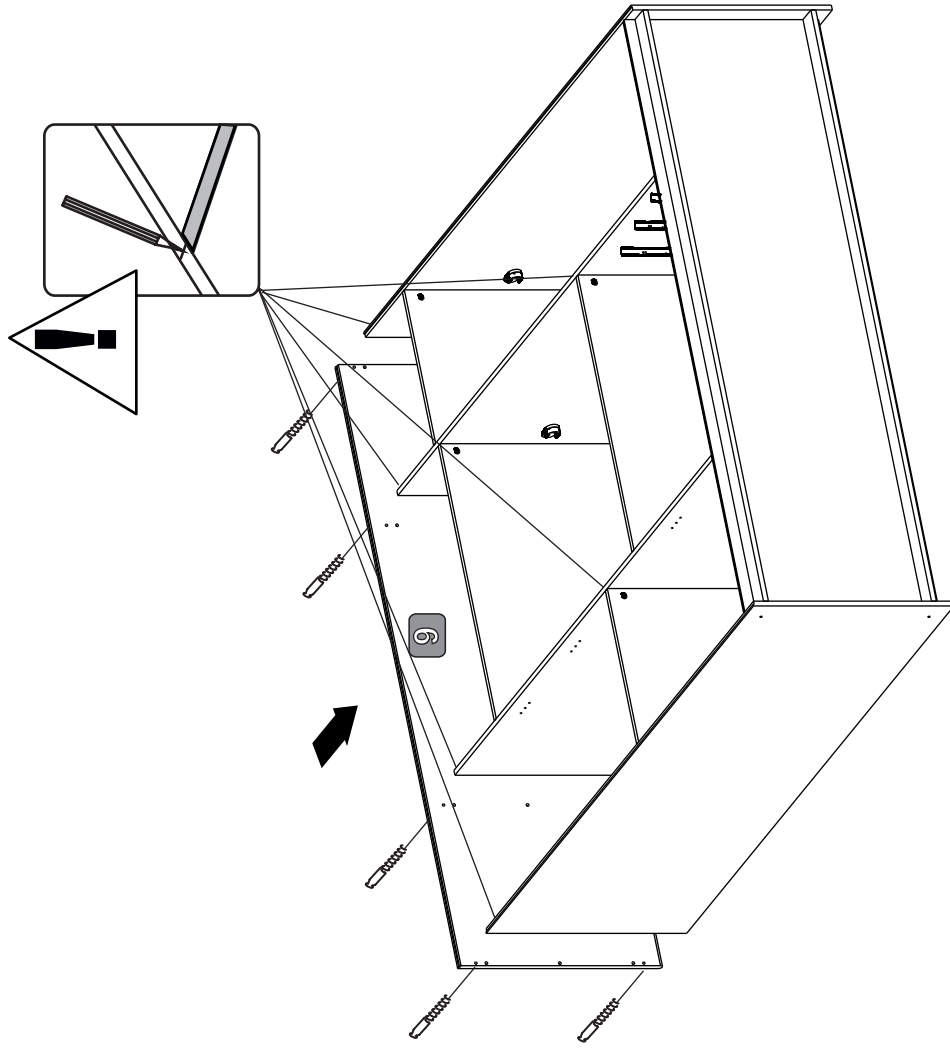
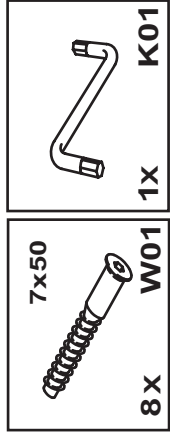

9

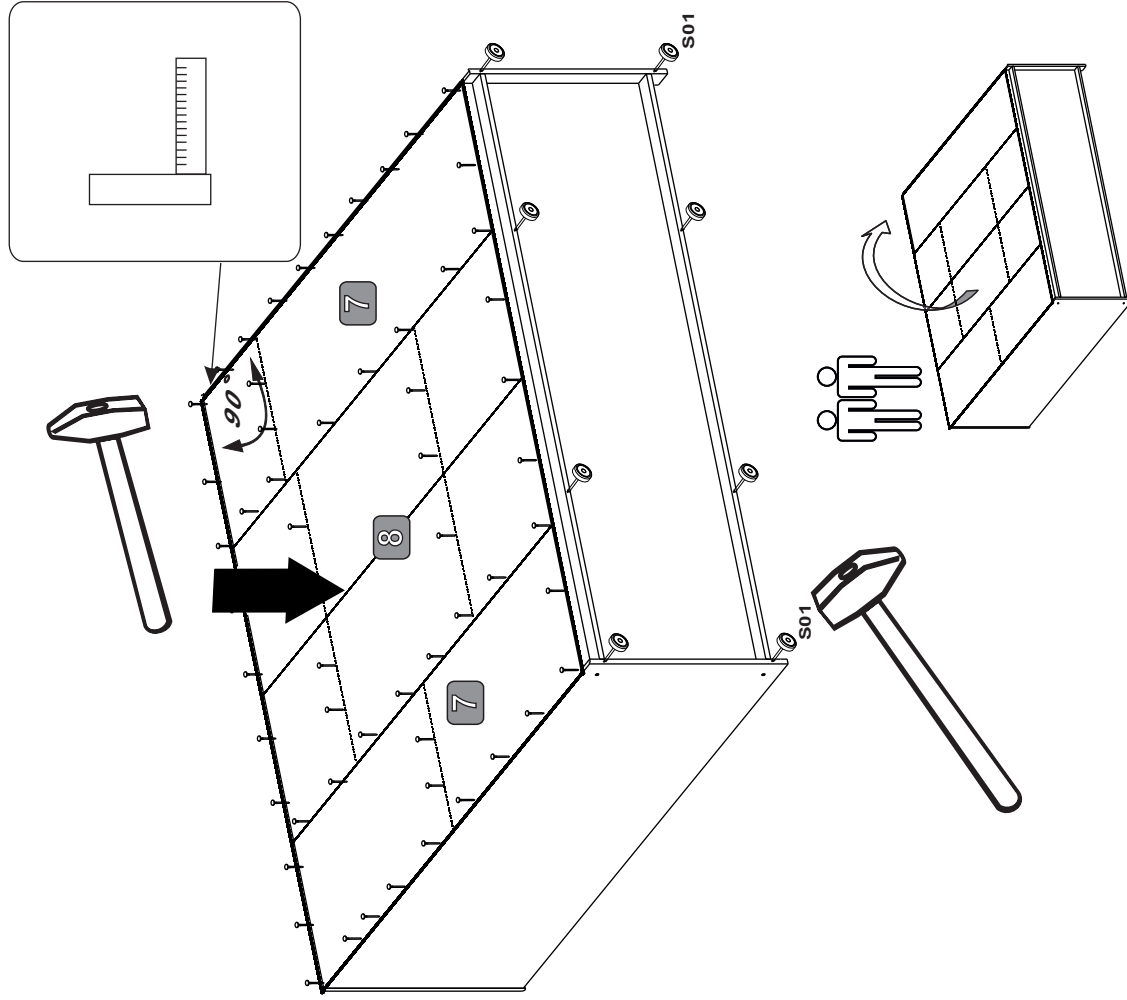
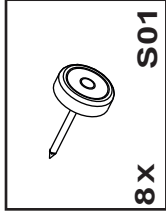
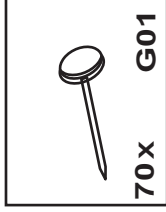

10

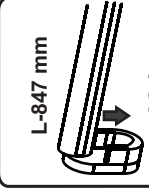
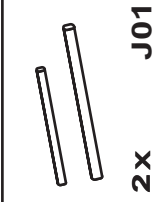
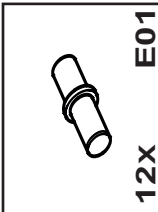
-  L-469 mm J01
-  L-847 mm J01
-  2x J01
-  12x E01

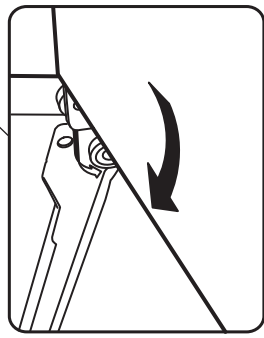
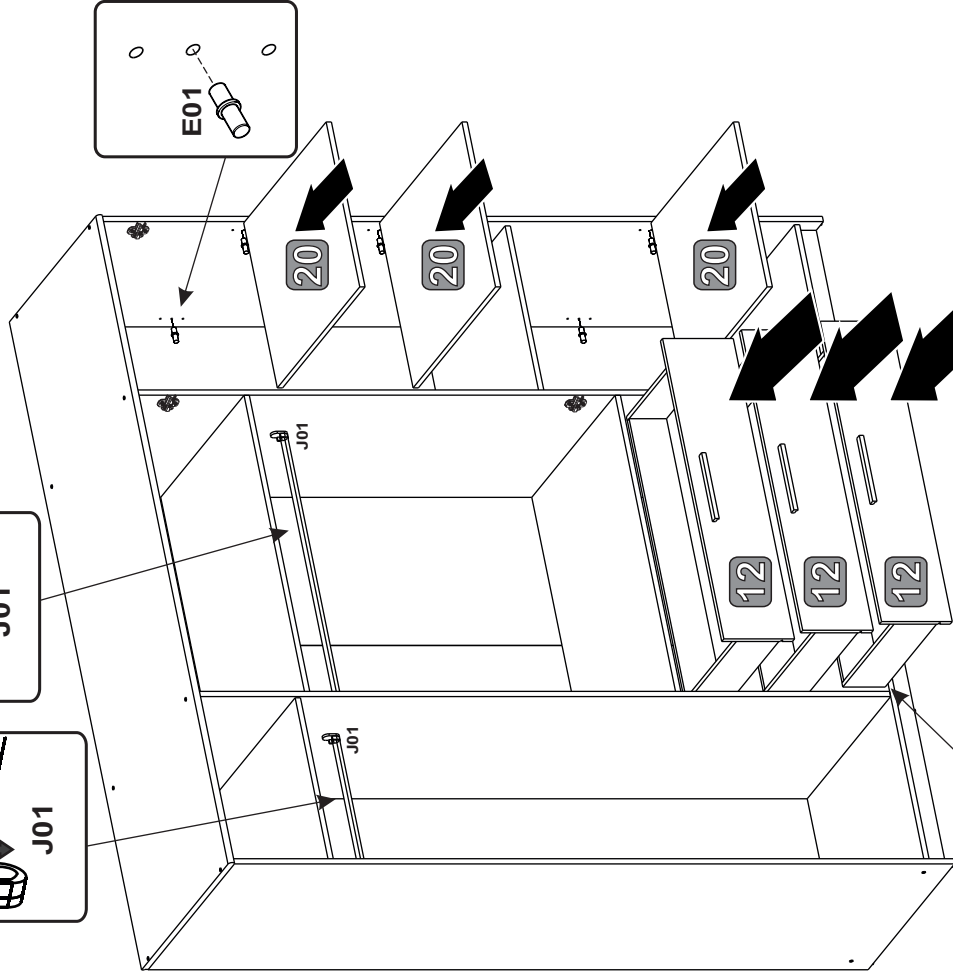

11

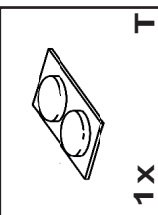
-  1x T 16x C01

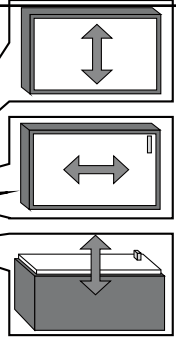
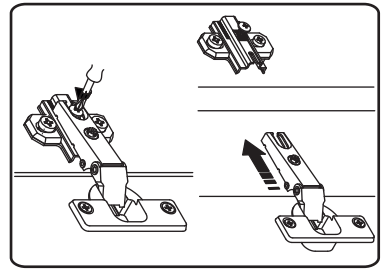
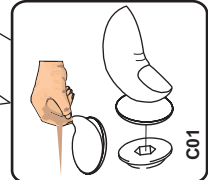
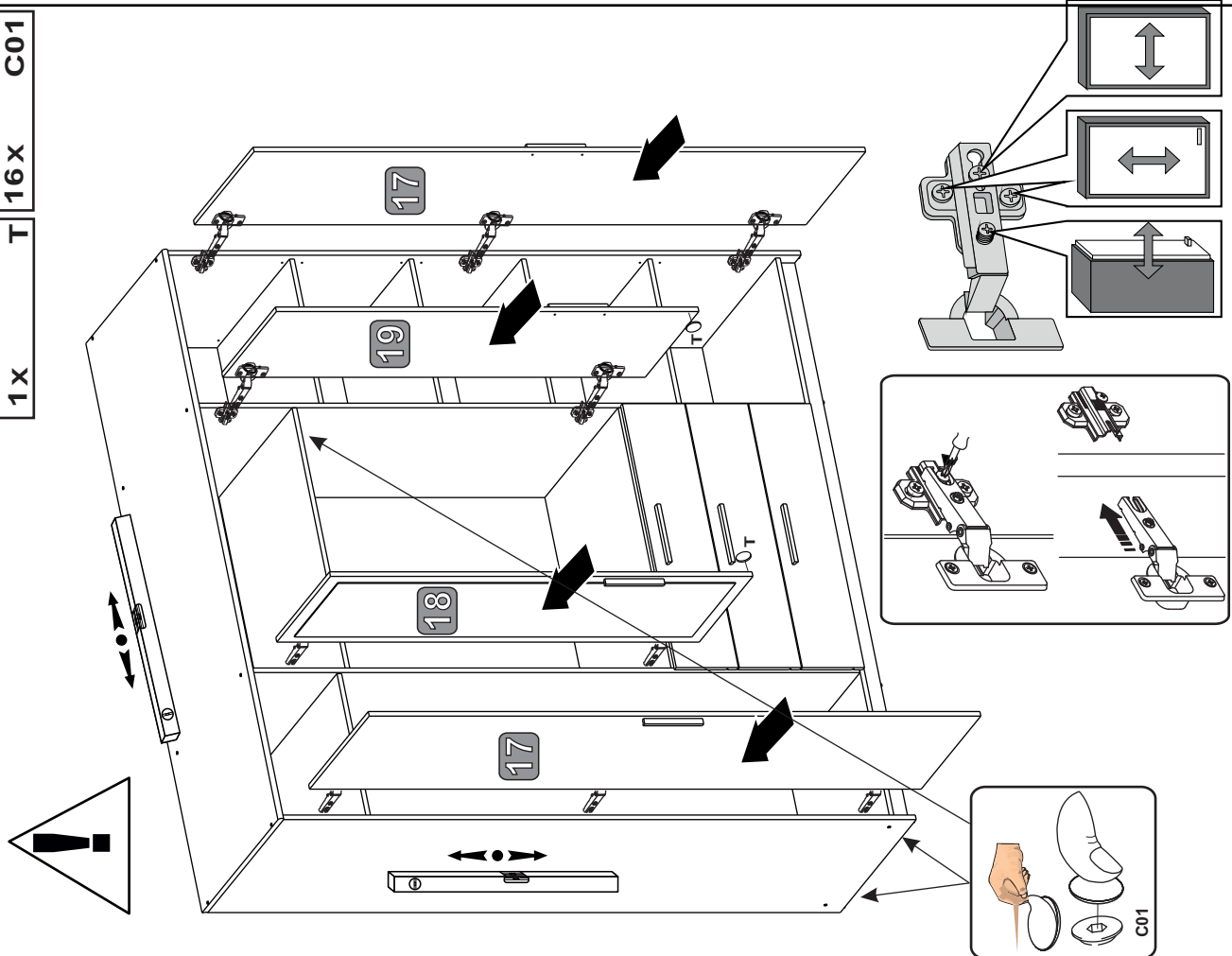

(GB)

Instructions for furniture maintenance

- The maintenance consists in regular cleaning the external and internal surfaces of the furniture.
- Remove any?stains or dirt regularly. The fresh stains are usually to be removed easier and completely
- Materials and agents for maintenance:
- RECOMMENDED** : soft fabric cloths while using proper cleaning and maintenance agents (it is recommended to apply commonly used foams and emulsions) however, before using them it is advisable to do the test on the invisible surface with the agents designed for using for this type of material
- UNACCEPTABLE** : rough sponges, scratchers, detergents, chemical solvents, polishes powders containing abrasive materials and it is also inadvisable to soak with a great amount of water.

(DE)

Anweisung zur Möbelpflege

- Pflege bedeutet regelmäßige Reinigung der äußeren und inneren Möbeloberfläche
- Flecken und Verschmutzungen laufend entfernen. Neue Flecken lassen sich gewöhnlich leicht und häufig völlig entfernen
- Pflegestoffe und -mittel:
- EMPFEHLENSWEERT**: Lappen aus weichem Stoff und entsprechendes Reinigungsmittel (empfehlenswert sind handelsübliche Schäumen und Emulsionen) allerdings wird vor der Anwendung der Reinigungsmittel ein Test auf der unsichtbare Oberfläche empfohlen
- UNZULÄSSIG**: harte Schwämme, Schrubber, Spülmittel, chemische Lösungsmittel, Pasten Pulver mit Schleifmittel sowie Nassmischen mit viel Wasser.

(FR)

Indications concernant la conservation des meubles

- La conservation consiste à un nettoyage régulier des surfaces externes et internes du meuble.
- Effacer les taches et les salures immédiatement. D'habitude, les taches fraîches sont plus faciles à effacer.
- Les matériaux et les substances destinés pour la conservation:
- RECOMMANDÉS** : les chiffons mous, en utilisant les moyens convenables destinés pour nettoyer et conserver les meubles (il est recommandé d'utiliser les crèmes et émulsions accessibles au marché) pourtant, avant d'utiliser un liquide, il est recommandé de faire un test sur une surface invisible avec des liquides destinés pour ce type de matériau
- INADMISSIBLES** : éponges dures, radaires, détergents, dissolvants chimiques, pâtes-poudres contenant les substances abrasives, il n'est recommandé non plus de mouiller les meubles avec de l'eau.

(NL)

Aanwijzingen voor het onderhouden van meubels

- Het onderhouden houdt het regelmatig reinigen van de meubels in.
- Verwijder steeds vlekken en vuil. Verse vlekken zijn gewoonlijk gemakkelijker en vaak in hun geheel te verwijderen.
- Onderhoudsmaterialen en -middelen:
- AANBEVOLEN**: doeken van zachte stof met reinigingsmiddelen (het gebruik van algemeen verkrijgbare schuim en emulsies wordt die bestemd zijn voor dat soort materiaal).
- AFGERADEN**: harde sponzen, kralen, dergenten, chemische oplosmiddelen, pasta's en poeders die schuurmiddelen bevatten. Het wordt ook afgeraden om grote hoeveelheden water te gebruiken.

(IT)

Indicazioni relative alla conservazione dei mobili

- La conservazione consiste in una pulizia sistematica delle superfici interne ed esterne del mobile.
- Togliere le macchie e sporchie immediatamente poiché lo sporco fresco solitamente ed interamente è più facile da eliminare.
- Materiali e mezzi per la conservazione:
- SI RACCOMANDA**: stracci di tessuto morbido con aggiunta di adeguati prodotti per la pulizia e conservazione (si raccomanda l'utilizzo di schiume ed emulsioni generalmente accessibili nel commercio). Tuttavia, prima di applicare tali prodotti, scelti in base alla superficie da trattare, occorre eseguire il test su una zona meno visibile.
- SONO VIETATI**: spugne dure, raschiatori, detergenti, paste e polveri contenenti sostanze abrasive. Inoltre, è da evitare di bagnare i mobili con l'acqua.

(HU)

Bűtör ápolására vonatkozó útmutatók

- Az ápoláshoz a bútor külső és belső felületének rendszeres tisztítása tartozik.
- Folyamatosan kell a foltokat és a szennyeződéseket eltávolítani. A friss foltok általában könnyebben és gyakran teljesen eltávolíthatók.
- Ápolási anyagok és szerek:
- JAVASOLT**: a tisztításhoz puha rongyot (ruhát) és megfelelő ápolási szereket használnunk (javasolt a kereskedelemben elérhető habok és emulziók használata) a tisztító-ápolási szerek használata előtt a nem látható (nem szembetűnő) felületen adott szerrel egy próbatesztet kell elvégezni .
- TILLOS**: a kemény szivacs, kaparó, mosószer, vegyi oldószer, sűrűszereket tartalmazó porok és pasztlák használata, a tisztításhoz nem szabad nagy mennyiségű vizet használni és abban zdatni.

(ES)

Indicaciones para conservación de los muebles

- La conservación consiste en la limpieza corriente de las superficies externas e internas del mueble.
- Quite las manchas y suciedades según vayan apareciendo. Las manchas recientes suelen quitarse ligera y completamente.
- Materiales y productos para conservación:
- SE RECOMIENDAN**: trapo de tela suave con la utilización de los productos correspondientes de limpieza y conservadores (se recomienda las espumas y emulsiones disponibles en el mercado). No obstante, antes de usar el producto de limpieza y conservador se recomienda hacer una prueba en la superficie invisible con los productos apropiados para este tipo de materia.
- NO SE ADMITE EL USO DE**: esponjas duras, metálicas, detergentes, disolventes, cremas, polvos que contienen agentes abrasivos. Tampoco se puede mojar el mueble con demasiada cantidad de agua.

(PL)

Wskazówki na temat Konserwacji mebli

- Konserwacja polega na regularnym czyszczeniu zewnętrznych i wewnętrznych powierzchni mebla.
- Na bieżąco usuwać plamy i zabrudzenia. Świeże plamy dają się najczęściej usunąć w cabości.
- Materiały i środki do konserwacji:
- ZALECANE**: ściereczki z miękkiej tkaniny z użyciem odpowiednich środków czyszcząco -konserwujących (zaleca się stosowanie ogólnie dostępnych pianek i emulsji) jednak przed użyciem środków czyszcząco - konserwujących zaleca się przeprowadzenie testu na powierzchni niewidocznej środkami przeznaczonymi dla tego typu tworzywa
- NIEDOPUSZCZALNE**: twarde gąbki, drapak, detergenty, rozpuszczalniki chemiczne, pasty proszki zawierające środki ściernie oraz niewskazane jest moczenie dużą ilością wody.

(CZ)

Pokyny pro údržbu nábytku

- Údržba spočívá v pravidelném čištění vnějších a vnitřních povrchů nábytku.
- Škvrny a nečistoty okamžitě odstraňujte. Čerstvé škrvny je možné snadněji a nejčastěji zcela odstranit
- Materiály a prostředky k údržbě:
- DOPORUČENÉ**: hadříky z měkké látky s použitím vhodných čistících a konzervačních prostředků (doporučuje se používání všeobecně přístupných pěnek a emulzí) avšak před použitím čistících a konzervačních prostředků se doporučuje provést test na neviditelné části, a to prostředky určenými pro tento typ látky.
- NEDOVOLENÉ**: tvrdé hubky, škrabáky, detergenty, chemické rozpouštědla, pasty prášky obsahující brusné prostředky) a nedoporučuje se močit příliš velkým množstvím vody.

(SK)

Pokyny pre údržbu nábytku

- Údržba spočíva v pravidelnom čistení vonkajších a vnútorných povrchov nábytku.
- Škrvny a znečistenia okamžite odstraňujte. Čerstvé škrvny môže sa ľahko a najčastejši celkom odstrániť.
- Materiály a prostriedky na údržbu:
- ODPORUČENÉ**: handričky z mäkkej látky s použitím vhodných čistiacich konzervačných prostriedkov (odporčuje sa používanie všeobecne prístupných pen a emulzií) avšak pred použitím čistiacich a konzervačných prostriedkov sa doporučuje provest test na neviditeľnej časti, a to prostriedkami určenými pre tento typ látky
- NEDOVOLENÉ**: tvrdé hubky, škrabáky, detergenty, chemické rozpúšťadla, pasty prášky obsahujúce brusné prostriedky) a neodporuje sa močiť príliš veľkým množstvom vody.

(HR)

Savjeti za Održavanje namještaja

- Održavanje se sastoji od redovitih čišćenja vanjskih i unutarnjih površina namještaja.
- Redovito uklanjati mrlje i prijavštine. Svježe mrlje mogu biti lakše i najčešće u potpunosti uklonjene.
- Materijali i sredstva za održavanje:
- PREPORUČAMO**: korištanje krpica od mekih tkanina i odgovarajuća sredstva za čišćenje i održavanje (preporuča se koristiti pjene i emulzije dostupne u prodaji) - ali prije nego počnete koristiti sredstva za čišćenje i održavanje, preporučujemo je provesti test tog sredstva na nevidljivoj površini materijala.
- NEDOVOLJENA SREDSTVA**: tvrda spužva, grebalice, deterdženti, hemijska otapala, sredstva u obliku pasti ili praška, koja sadrže abrazivna sredstva, ne preporuča se namakanje velikim količinama vode.

(TR)

Mobilya bakımı talimatı

- Mobilya bakımı, mobilyanın iç ve dış yüzeylerinin muntazam bir biçimde temizlenmesinden oluşur.
- Oluşan leke ve kirlenmeleri derhal giderin. Taze lekeler genellikle kolay ve tümtüyle çıkar.
- Mobilya bakımı malzeme ve araçları
- TAVSİYELER**: yumuşak bez ve uygun temizleme-bakım araçları (piyasadaki köpük ve emülsiyonlar) tavsiye edilir. Asıl temizlemeye geçmeden önce kullanacağınız ilacı mobilyanın görülmeyen yüzeyinde test etmeyi ihmal etmeyiniz.
- UYARI**: sert sünger, tel sünger, tiner, çizici özelliği olan deterjan, toz deterjan asla kullanılmayın. Mobilya yüzeylerini fazla ıslatmayın

(RO)

Statuti pentru întreținerea mobilei

- Întreținerea constă în curățarea regulată a suprafețelor exterioare și interioare ale mobilierului.
- Petele și murdăria trebuie sc îndepărtate imediat. De obicei, petele proaspete pot să fie mai ușor și complet eliminate.
- Materiale și detergenți de întreținere:
- RECOMANDATE**: ștergerea cu o cârpă moale, și utilizarea unor detergenți pentru curățare și întreținere (este recomandat să utilizezi spume disponibile în comerț și emulsii) cu toate acestea, înainte de aplicarea detergenților pentru curățare-întreținere, se recomandă să se efectueze testul pe o suprafață disponibilă învizibilă din acest tip de material
- NICIODATĂ**: bureți duri, lavete abrazive, detergenți, substanțe chimice, pulberi, paste care conțin substanțe abrazive; nu este recomandată nici umezirea cu o cantitate mare de apă

(RU)

Рекомендации по уходу за мебелью

- Уход за мебелью предусматривает регулярную протирку внешней и внутренней поверхности мебели.
- Пятна и загрязнения снимают сразу же. Свежие пятна удаляются легче и зачастую полностью.
- Материалы и средства по уходу:
- РЕКОМЕНДУЕМЫЕ**: тряпочки из мягкой ткани с применением соответственных чистяще-консервирующих средств (рекомендуется применение общедоступных пенок и эмульсий). Однако, перед применением чистяще-консервирующего средства следует провести тест на закрытой поверхности мебели.
- НЕ РЕКОМЕНДУЕМЫЕ**: жесткие губки, наждаки, детергенты, химические растворители, пасты и порошки с содержанием абразивных веществ. Не допускать скопления воды на поверхности мебели.