

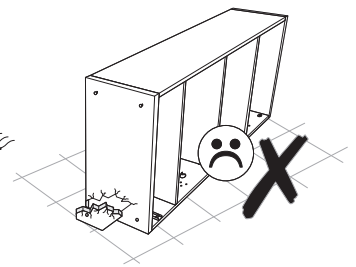

# SANTA FE 89-160-A,B

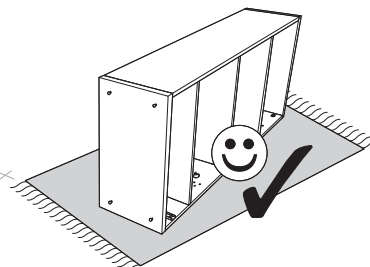

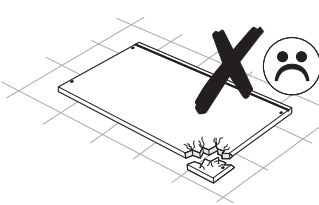
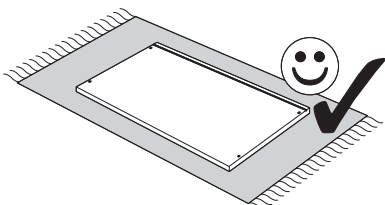
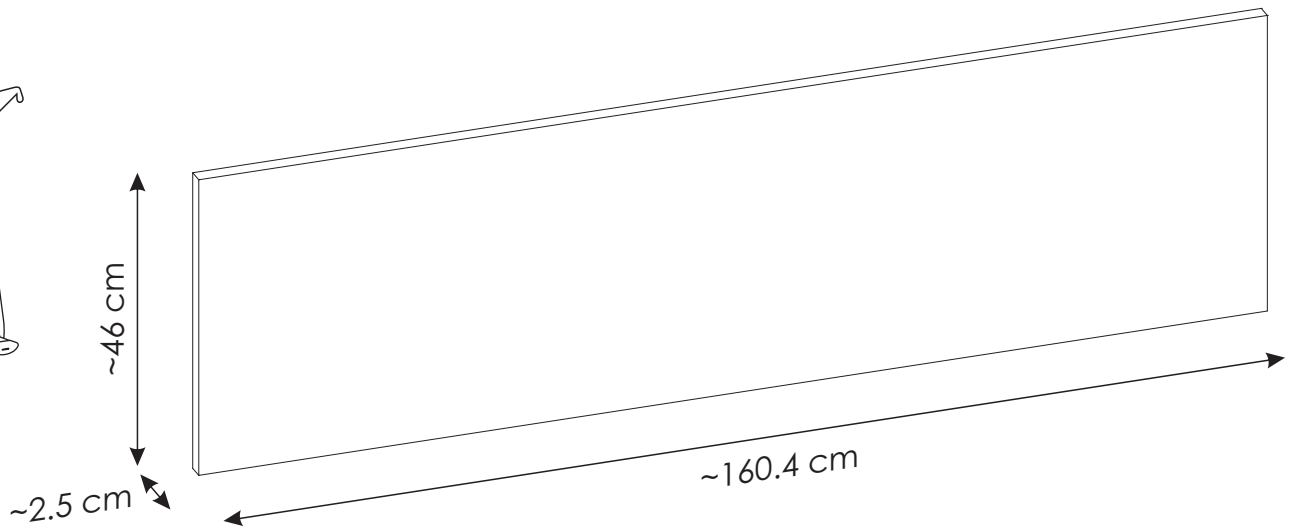
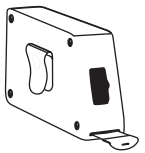
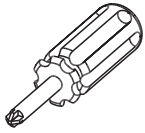
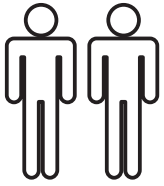
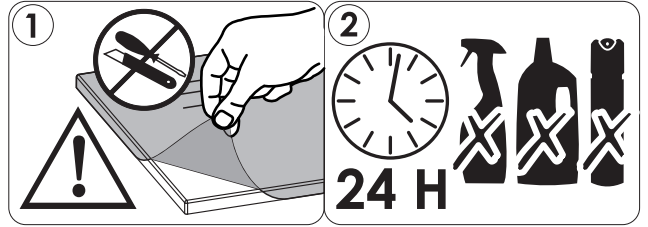
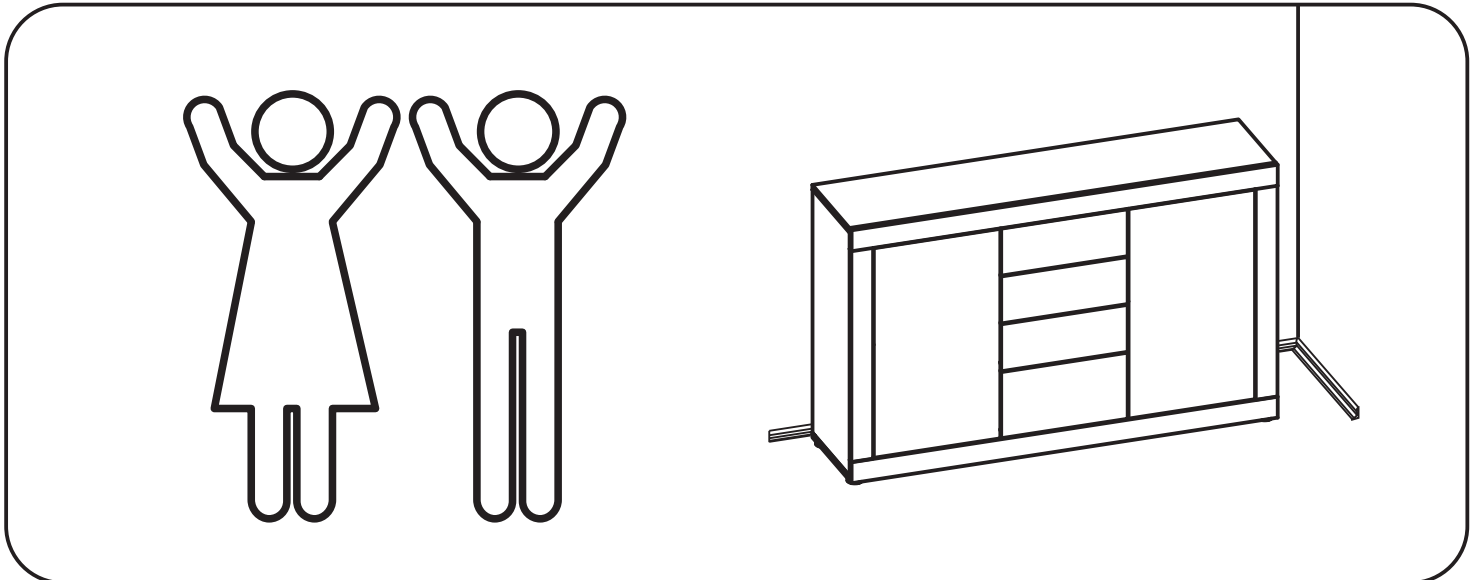
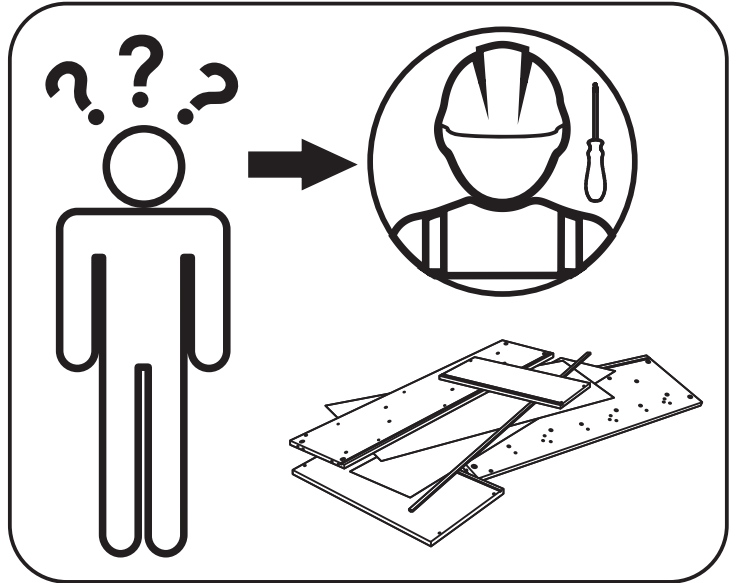
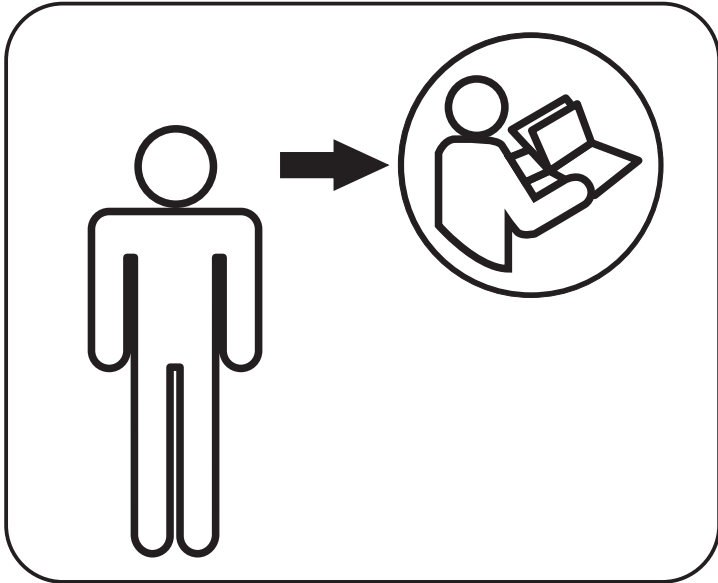
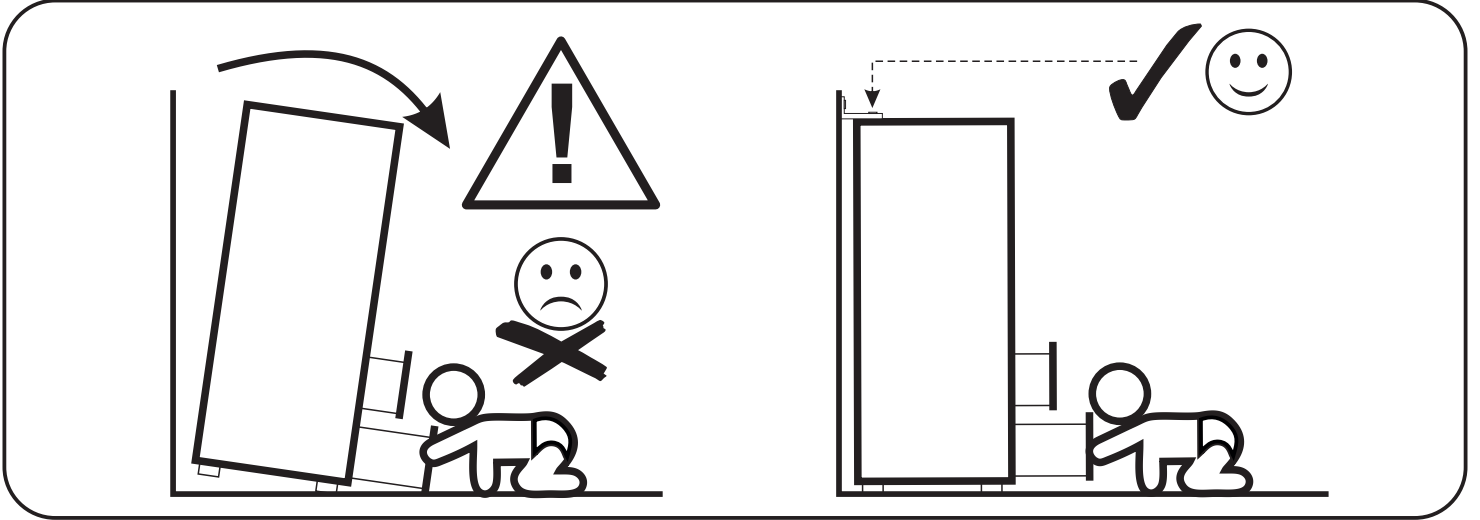
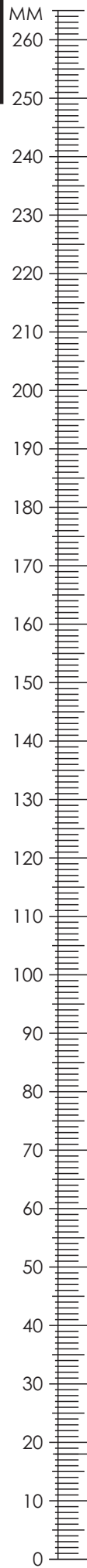

# SANTA FE 89-160-A,B

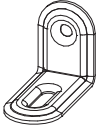

<b>N5</b>	3,5 x 16 mm	x24	<b>Q8</b>	x12
				

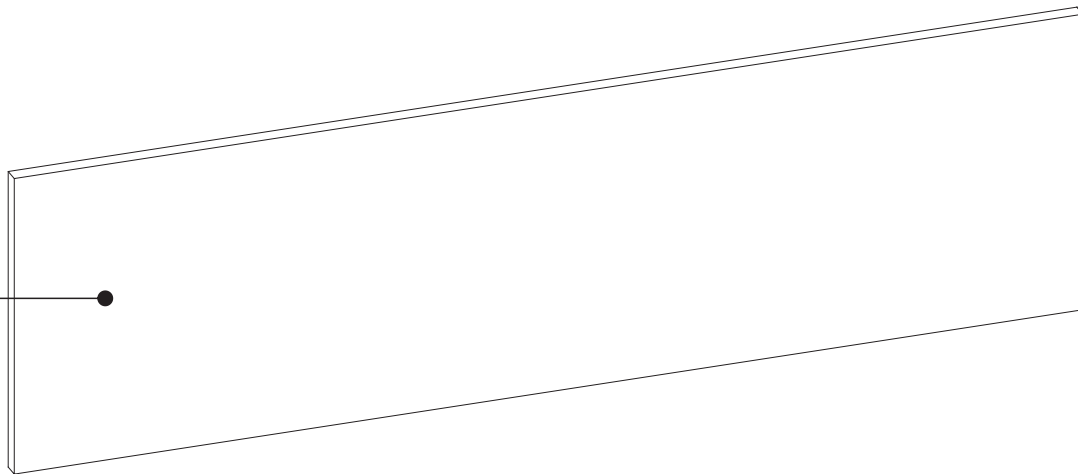

<b>1</b>	1604	460	25	x1	1/1
----------	------	-----	----	----	-----



1 ▶

x2

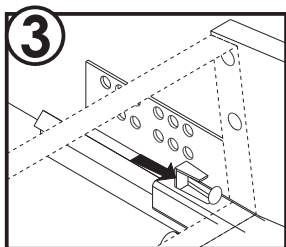
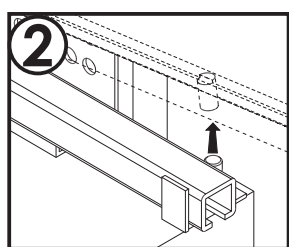
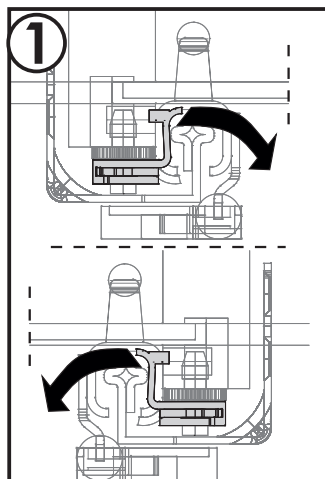
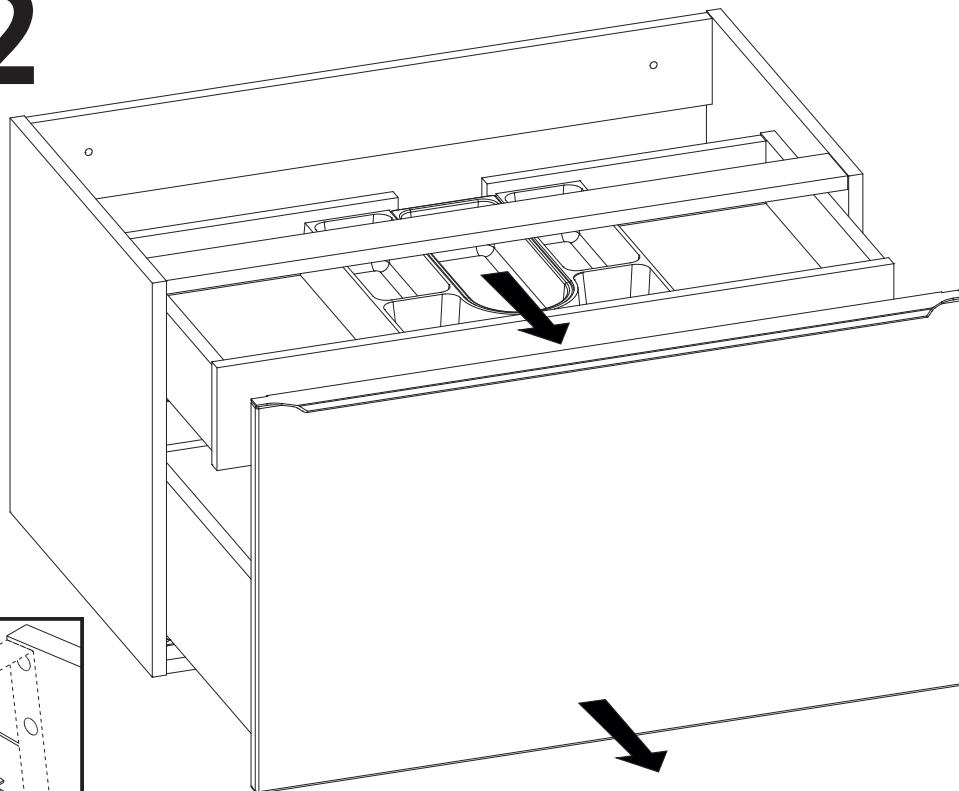

2 ▶

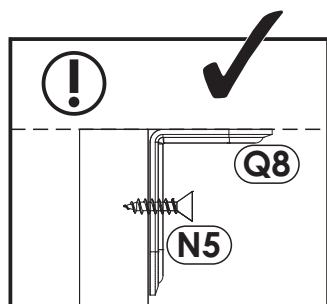

x2

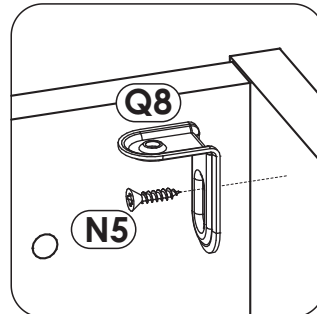
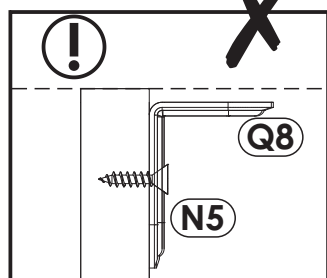

x6

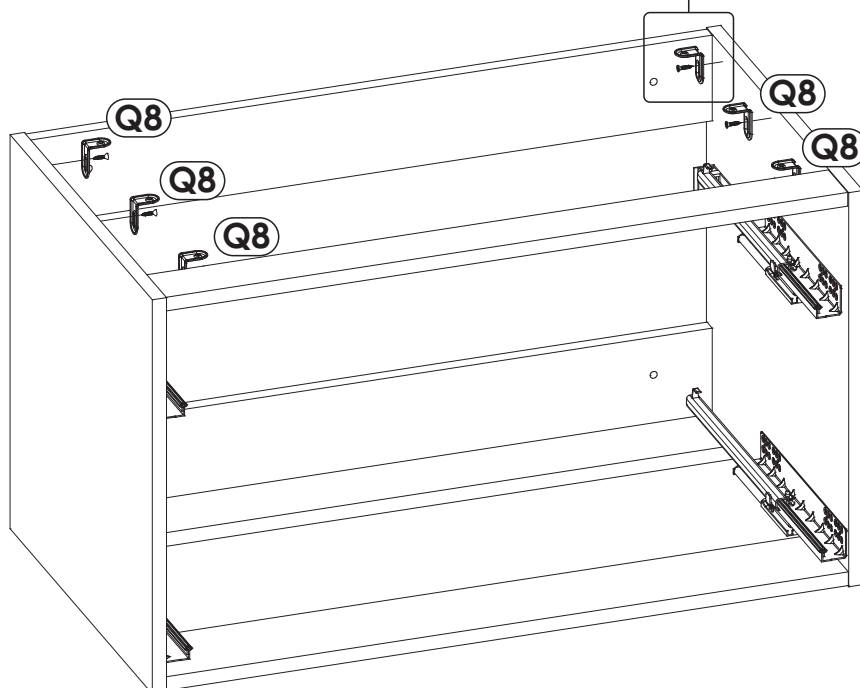

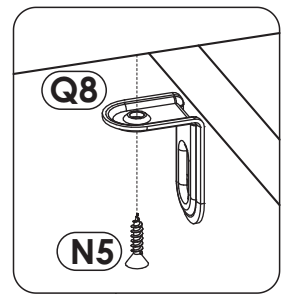
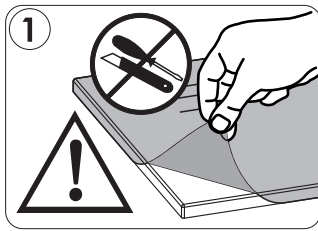
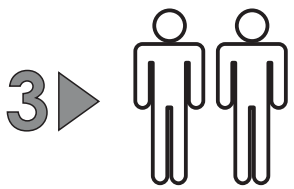

x12

