

3

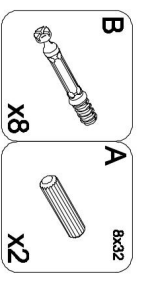

4

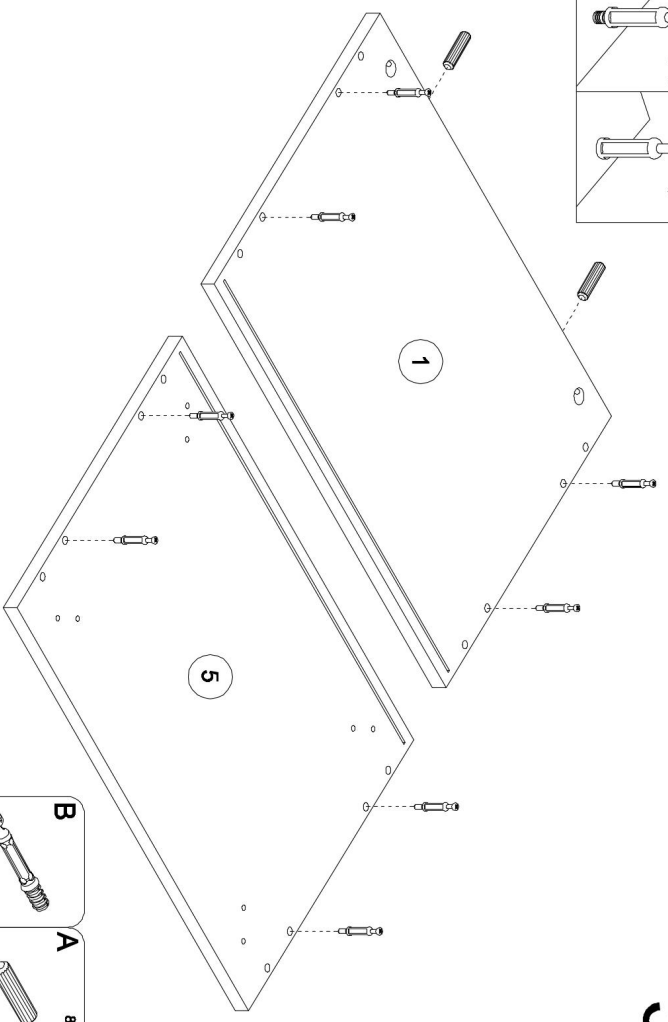
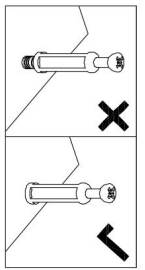
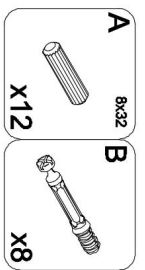
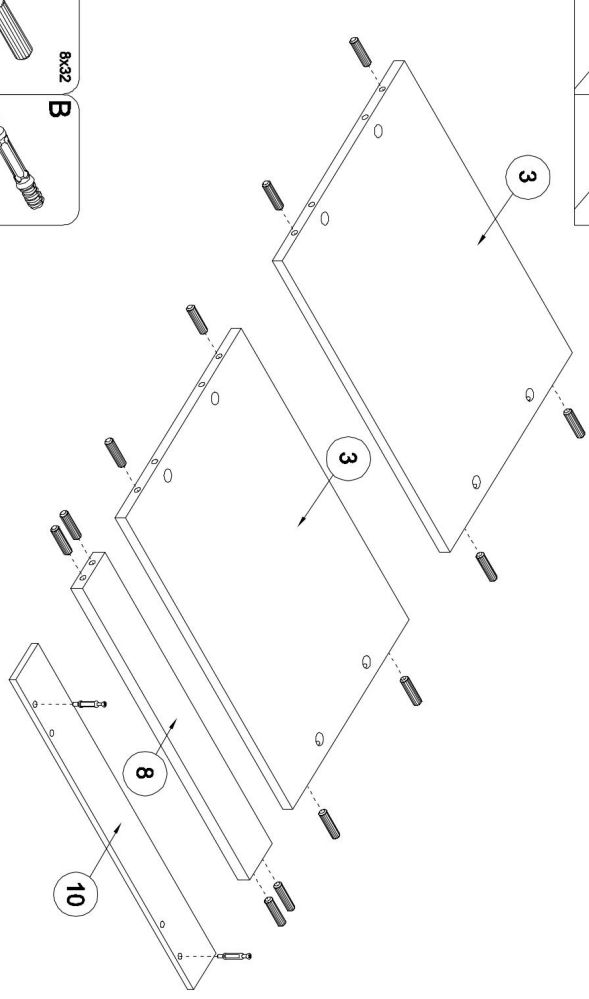
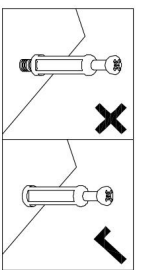

5

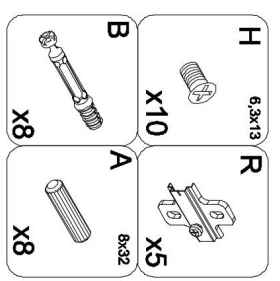
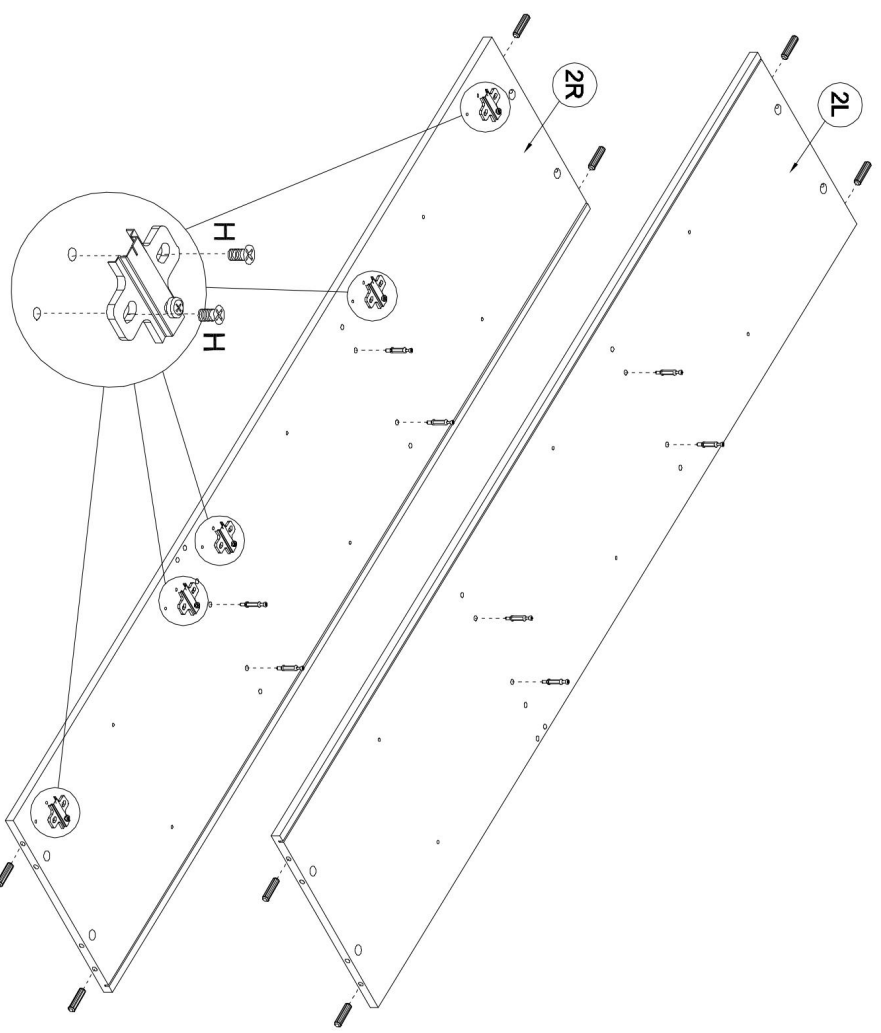
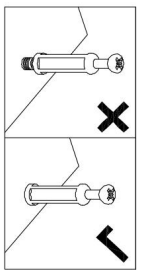

ND 3.5x16 x10	ZD
PC x5	NC 4x16 x6

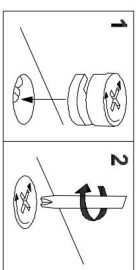
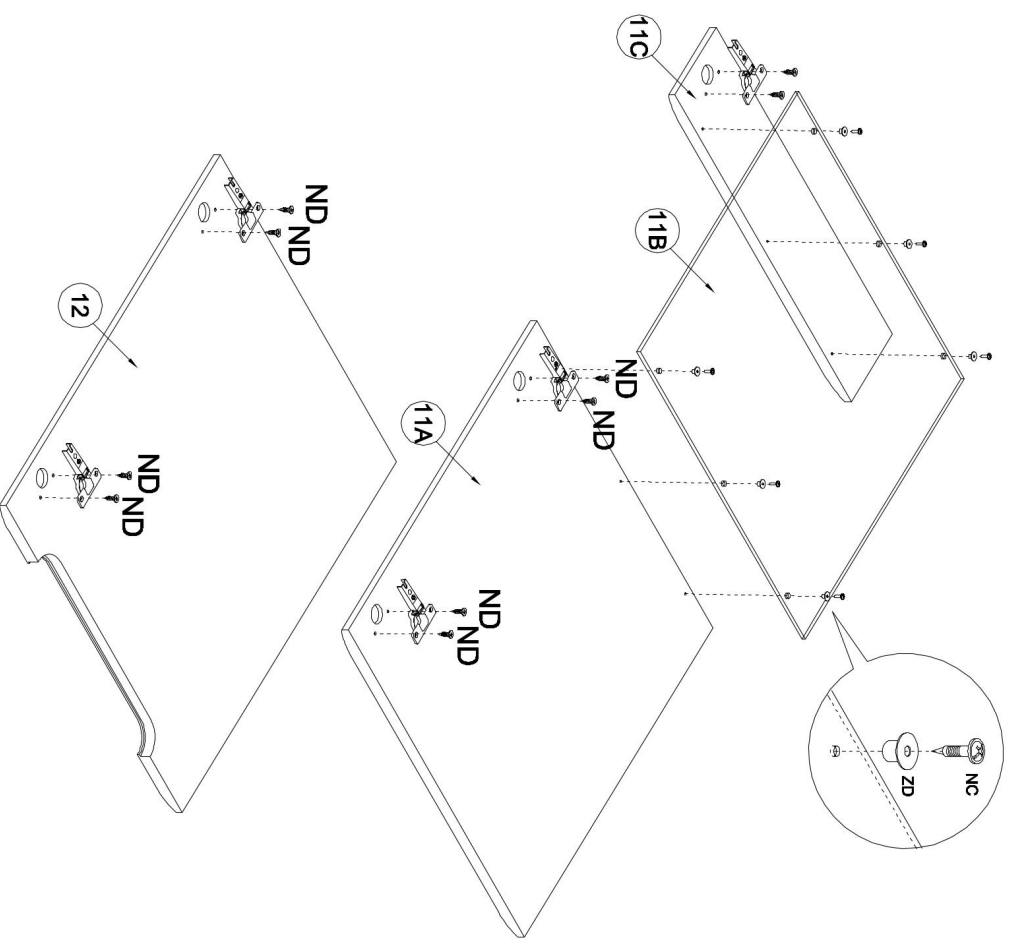

C x8	Z x8
---------	---------

C x2	Z x2
---------	---------

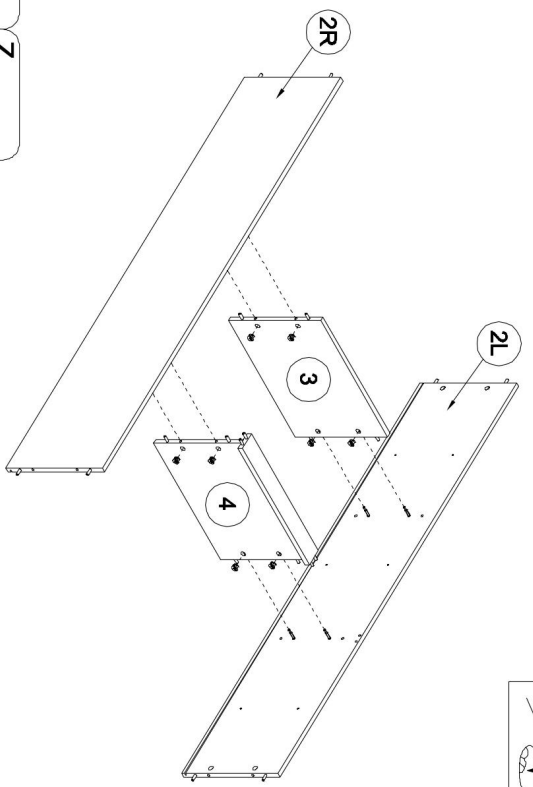
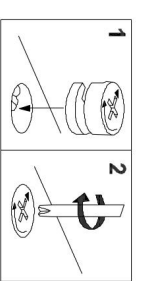
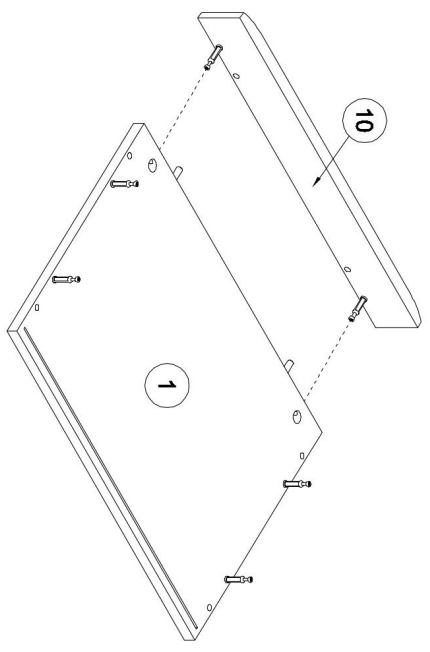

11

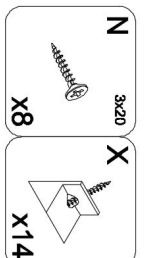
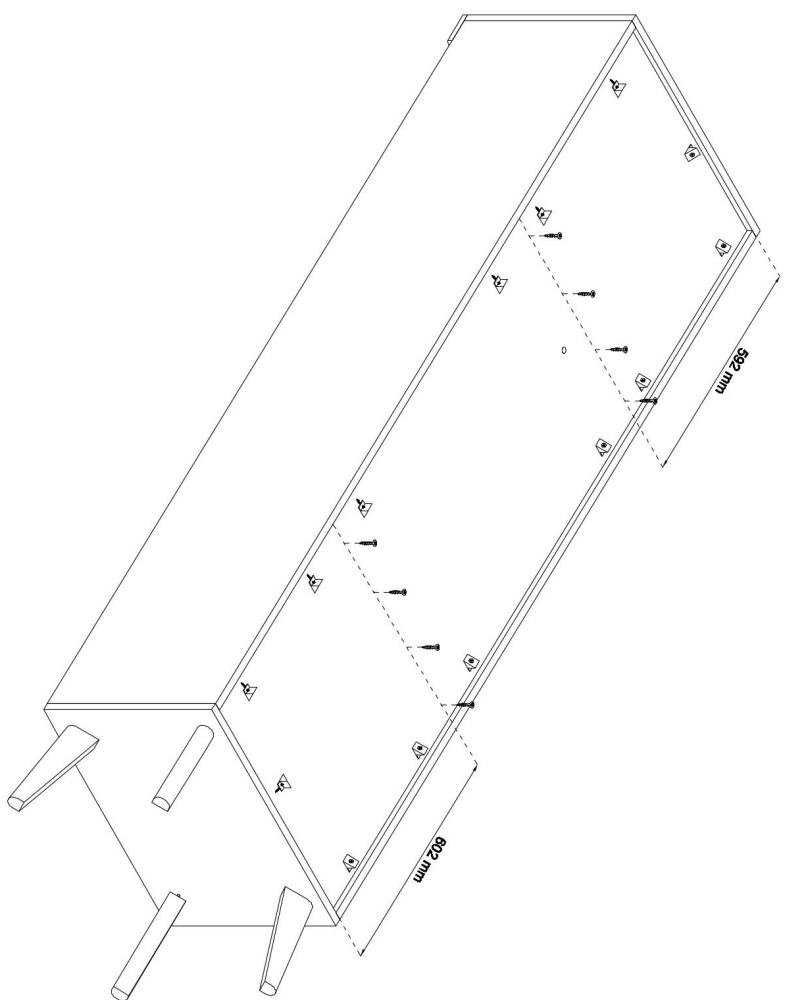
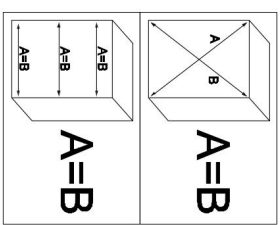

9

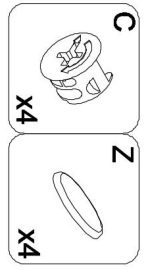
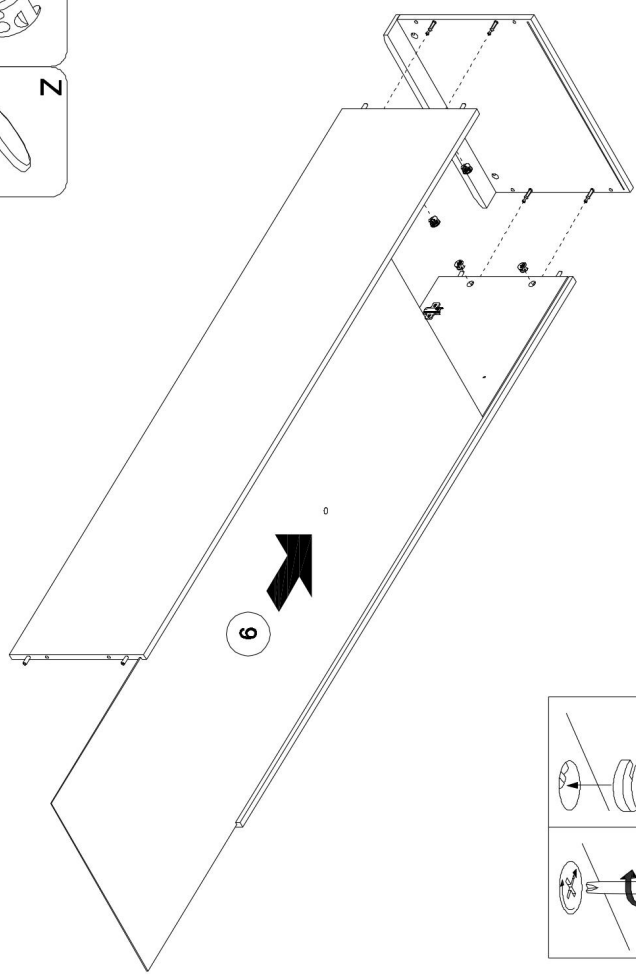
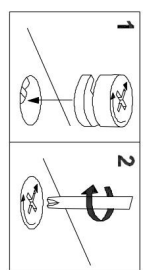

10

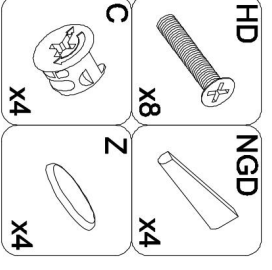
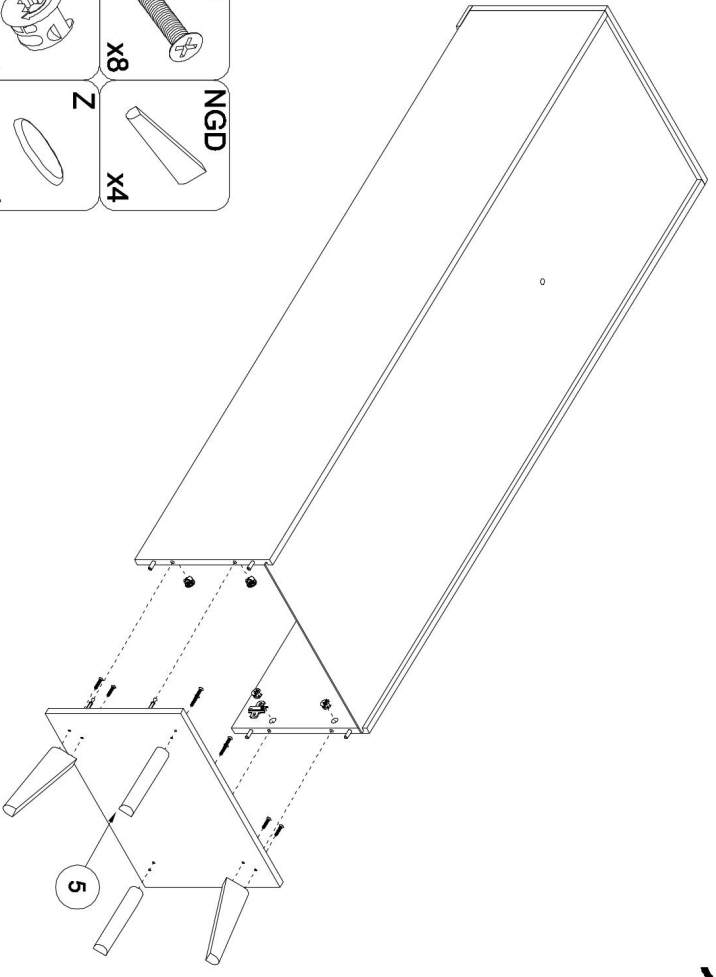

12

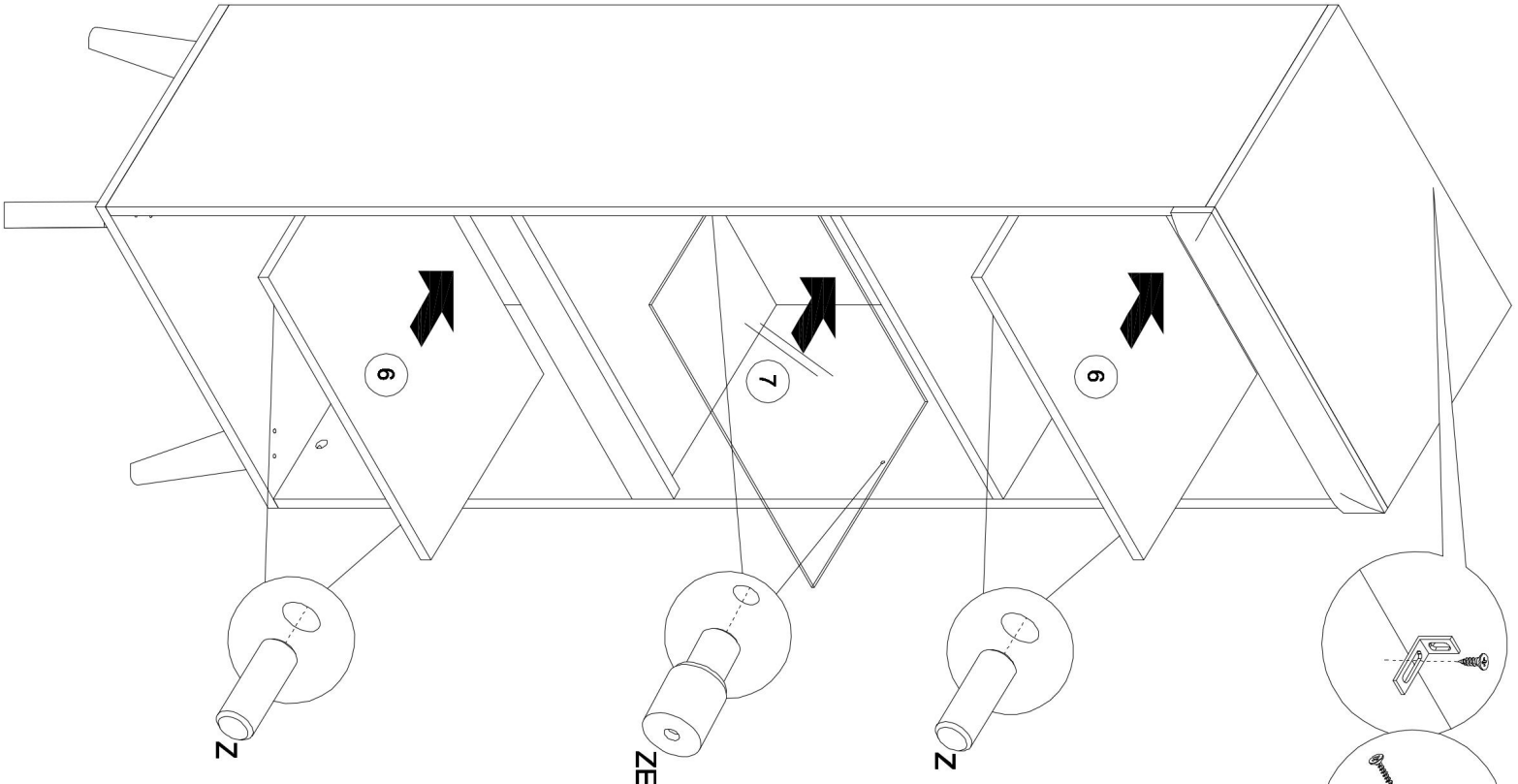
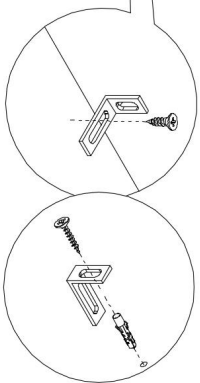

- | | |
|-----------------|--|
| TB
x1 | |
| ZE
x4 | |
| TA
x1 | |
| Z
x8 | |

13

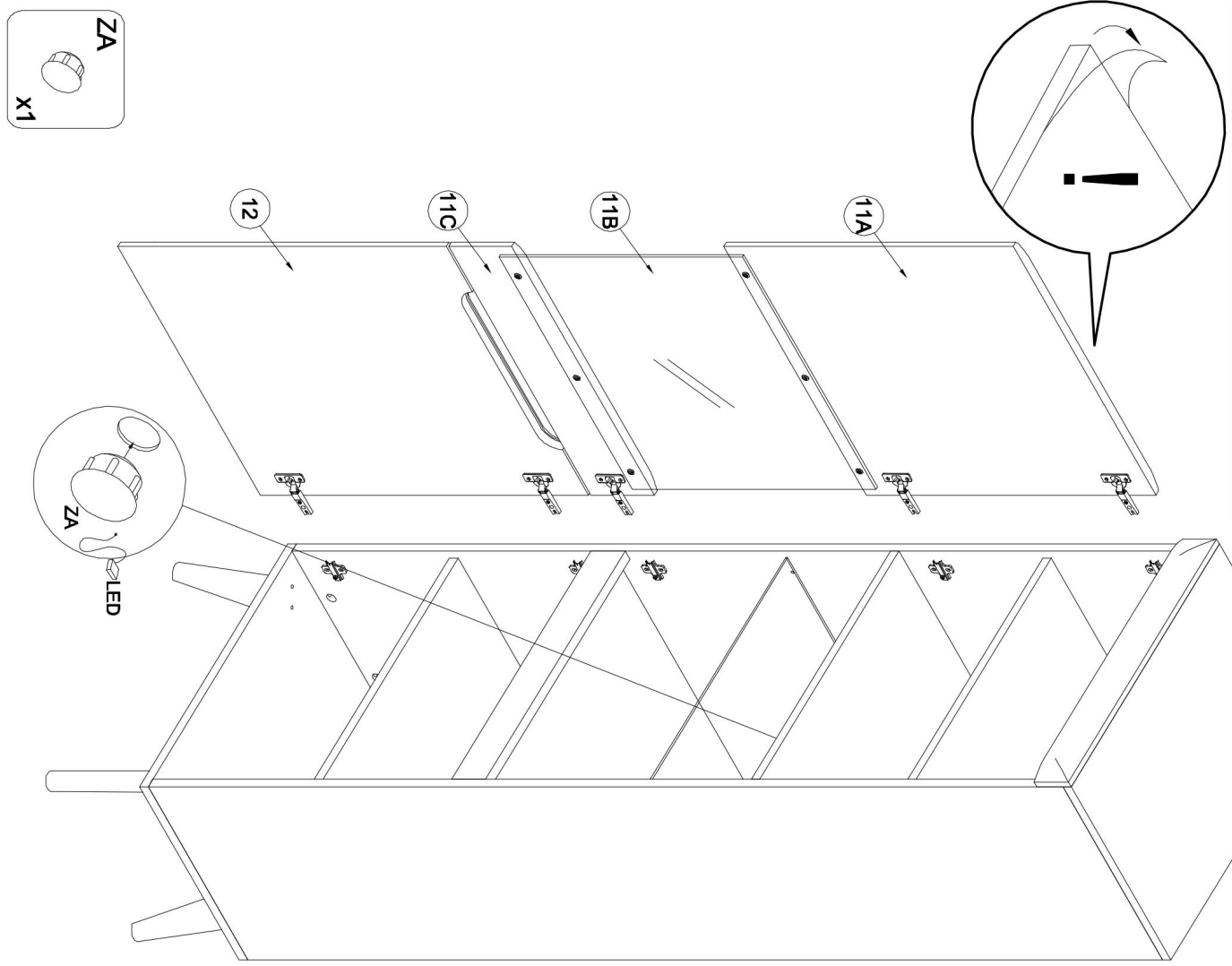
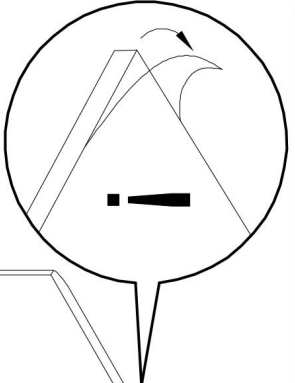
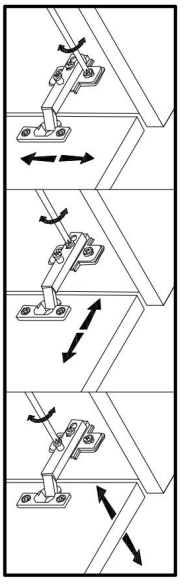

- | | |
|-----------------|--|
| ZA
x1 | |
|-----------------|--|