

FAVI SSZ 110

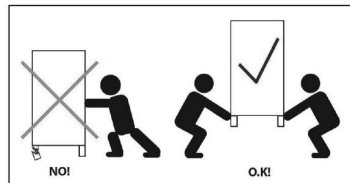

21.10.2014.

- | | |
|---|-------------------------------------|
| (D) Montageanleitung | (GB) Assembly Instructions |
| (FR) Notice de montage | (IT) Istruzioni di montaggio |
| (NL) Handleiding voor de montage | (PL) Instrukcja montażu |
| (CZ) Montážní návod | (SK) Návod na montáž |
| (HU) Szerelési útmutató | (RO) Instrucțiuni de montaj |
| (TR) Montaj talimatı | (RU) ИНСТРУКЦИЯ ПО МОНТАЖУ |

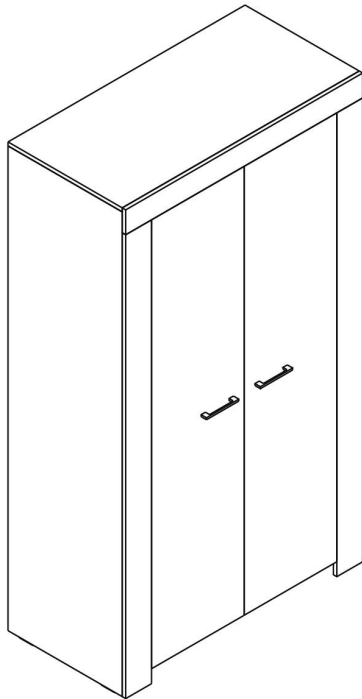
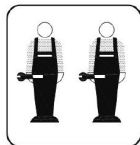
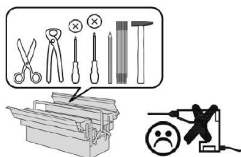

1,5 - 2

1

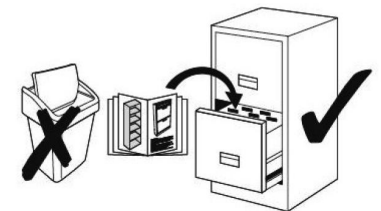
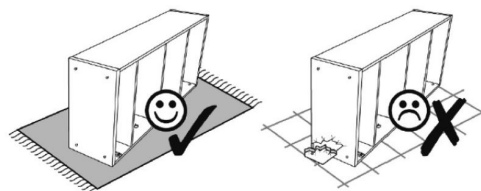
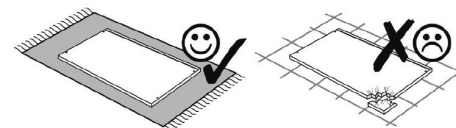
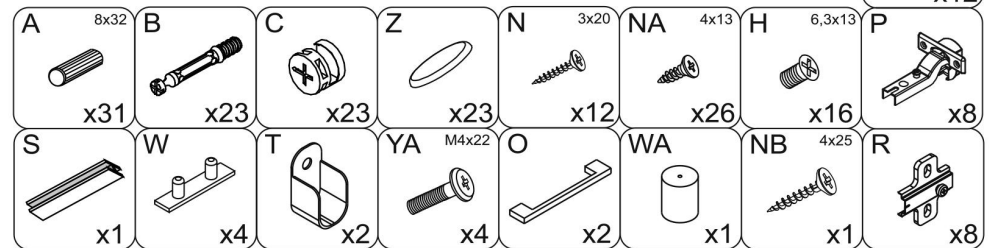
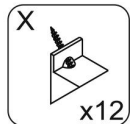
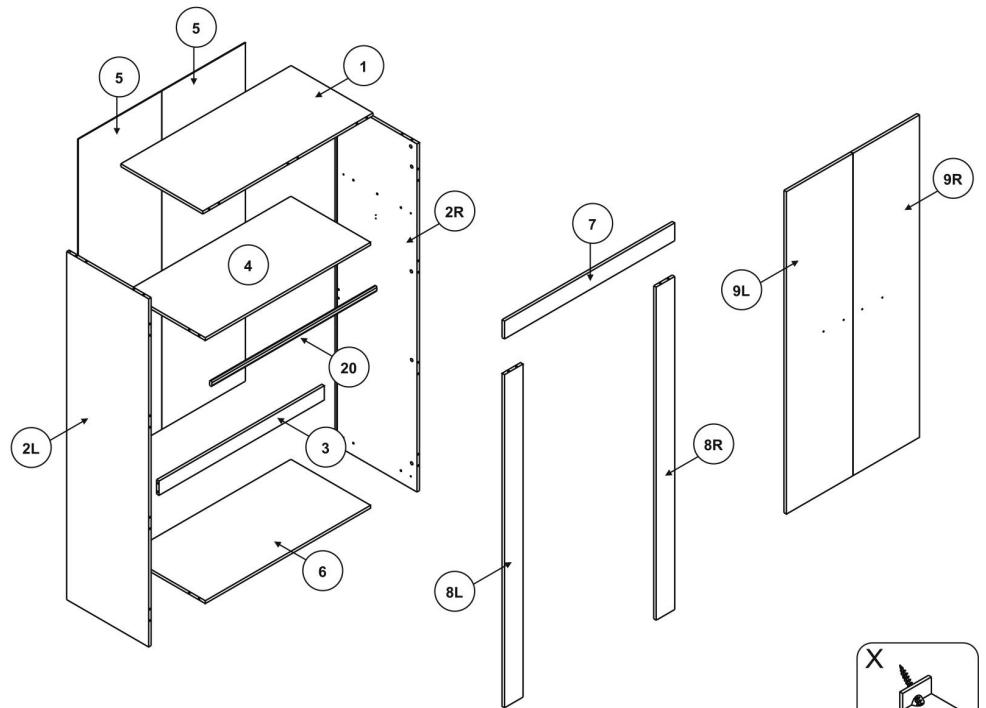

2

